



**325HAV**

**Air Sourced Heat Pump Water Heater**



**Owner's Guide  
and  
Installation Instructions**

This water heater must be installed and serviced by a qualified person.  
Please leave this guide with the householder.

---

An electronic copy of these Owner's Guide and Installation Instructions can be downloaded from [solahart.com.au](http://solahart.com.au).

**PATENTS**

This water heater may be protected by one or more patents or registered designs in the name of Solahart Industries Pty Ltd or Rheem Australia Pty Ltd.

**TRADE MARKS**

® Registered trademark of Solahart Industries Pty Ltd or Rheem Australia Pty Ltd.  
™ Trademark of Solahart Industries Pty Ltd or Rheem Australia Pty Ltd.

**Note:** Every care has been taken to ensure accuracy in preparation of this publication. No liability can be accepted for any consequences, which may arise as a result of its application.

---

# CONTENTS

---

## HOUSEHOLDER

This booklet contains important information about your new water heater, including terms of the Solahart warranty.

We recommend you read pages 7 to 22, and the terms of the Solahart warranty on pages 4 to 6.

The other pages are intended for the installer but may be of interest.

<b>Warranty .....</b>	<b>4</b>
<b>Safety, Warnings, Installation Notes .....</b>	<b>7</b>
<b>About Your Water Heater .....</b>	<b>10</b>
<b>Maintenance Requirements.....</b>	<b>15</b>
<b>Water Supplies.....</b>	<b>16</b>
<b>Save A Service Call .....</b>	<b>18</b>
<b>Installation.....</b>	<b>23</b>
<b>Heat Pump And Tank Assembly .....</b>	<b>30</b>
<b>Connections – Plumbing .....</b>	<b>40</b>
<b>Connections – Electrical.....</b>	<b>43</b>
<b>Commissioning.....</b>	<b>45</b>
<b>Draining The Water Heater .....</b>	<b>48</b>
<b>Installation Report .....</b>	<b>49</b>
<b>Solahart Offices .....</b>	<b>52</b>

---

# **SOLAHART HEAT PUMP WATER HEATER WARRANTY - AUSTRALIA ONLY -**

---

## **HEAT PUMP WATER HEATER MODEL 325HAV**

### **1. THE SOLAHART WARRANTY – GENERAL**

- 1.1 This warranty is given by Solahart Industries Pty Limited ABN 45 064 945 848 of 1 Alan Street, Rydalmere New South Wales.
- 1.2 Solahart offers national service through its Dealer network. Solahart will repair or replace components at the address of the water heater subject to the terms of the Solahart warranty. Solahart, in addition can provide preventative maintenance and advice on the operation of your water heater.
- 1.3 For details about this warranty, you can contact us on 1800 638 011.
- 1.4 The terms of this warranty and what is covered by it are set out in sections 2 and 3 and apply to water heaters manufactured from the 1<sup>st</sup> February 2019.
- 1.5 If a subsequent version of this warranty is published, the terms of that warranty and what is covered by it will apply to water heaters manufactured after the date specified in the subsequent version.

### **2. TERMS OF THE SOLAHART WARRANTY AND EXCLUSIONS TO IT**

- 2.1 The decision of whether to repair or replace a faulty component is at Solahart's sole discretion.
- 2.2 If you require a call out and we find that the fault is not covered by the Solahart warranty, you are responsible for our standard call out charge. If you wish to have the relevant component repaired or replaced by Solahart, that service will be at your cost.
- 2.3 Where a failed component or cylinder is replaced under this warranty, the balance of the original warranty period will remain effective. The replacement does not carry a new Solahart warranty.
- 2.4 Where the water heater is installed outside the boundaries of a metropolitan area as defined by Solahart or further than 30 km from a regional Solahart Dealer, the cost of transport, insurance and travelling between the nearest Solahart Dealer's premises and the installed site shall be the owner's responsibility.
- 2.5 Where the water heater is installed in a position that does not allow safe or ready access, the cost of that access, including the cost of additional materials handling and/or safety equipment, shall be the owner's responsibility. In other words, the cost of dismantling or removing cupboards, doors or walls and the cost of any special equipment to bring the water heater to floor or ground level or to a serviceable position is not covered by this warranty.
- 2.6 This warranty only applies to the original and genuine Solahart water heater in its original installed location and any genuine Solahart replacement parts.
- 2.7 The Solahart warranty does not cover faults that are a result of:
  - a) Accidental damage to the water heater or any component (for example: (i) Acts of God such as floods, storms, fires, lightning strikes and the like; and (ii) third party acts or omissions).
  - b) Misuse or abnormal use of the water heater.
  - c) Installation not in accordance with the Owner's Guide and Installation Instructions or with relevant statutory and local requirements in the State or Territory in which the water heater is installed.
  - d) Connection at any time to a water supply that does not comply with the water supply guidelines as outlined in the Owner's Guide and Installation Instructions.
  - e) Repairs, attempts to repair or modifications to the water heater by a person other than the Solahart Dealer or a Solahart Accredited Service Agent.
  - f) Faulty plumbing or faulty power supply.

# SOLAHART HEAT PUMP WATER HEATER WARRANTY - AUSTRALIA ONLY -

## HEAT PUMP WATER HEATER MODEL 325HAV

- g) Failure to maintain the water heater in accordance with the Owner's Guide and Installation Instructions.
  - h) Transport damage.
  - i) Fair wear and tear from adverse conditions (for example, corrosion).
  - j) Cosmetic defects.
  - k) Ice formation in the waterways of a water heater system incorporating a freeze protection system where the electricity supply has been switched off or has failed.
- 2.8 Solahart may reject a claim under this warranty in its sole discretion if a third party solar diverter is connected to the water heater.
- 2.9 Subject to any statutory provisions to the contrary, this warranty excludes any and all claims for damage to furniture, carpet, walls, foundations or any other consequential loss either directly or indirectly due to leakage from the water heater, or due to leakage from fittings and/ or pipe work of metal, plastic or other materials caused by water temperature, workmanship or other modes of failure.

### 3. WHAT IS COVERED BY THE SOLAHART WARRANTY FOR THE WATER HEATERS DETAILED IN THIS DOCUMENT

- 3.1 Solahart will repair or replace a faulty component of your water heater if it fails to operate in accordance with its specifications as follows:

What components are covered	The period from the date of installation in which the fault must appear in order to be covered	What coverage you receive
<b>325HAV model</b>		
<b>All components</b> (all installations)	Year 1	Repair and/or replacement of the faulty component, free of charge, including labour.
<b>All components</b> (if the water heater is installed in a single-family domestic dwelling)	Year 2	Repair and/or replacement of the faulty component, free of charge, including labour.
<b>The cylinder</b> (if the water heater is installed in a single-family domestic dwelling)	Year 3	Repair and / or replacement of the cylinder, free of charge, including labour.
	Years 4 & 5	Replacement cylinder, free of charge. Installation and repair labour costs are the responsibility of the owner.
<b>The cylinder</b> (if the water heater is <u>not</u> installed in a single-family domestic dwelling)	Years 2 & 3	Replacement cylinder, free of charge. Installation and repair labour costs are the responsibility of the owner.

- 3.2 Without limiting the periods shown in the table in Clause 3.1, a 5-year whole-of-product warranty applies where a rebate has been received under Solar Victoria's Solar Homes Program for a water heater installed from the 1<sup>st</sup> July 2023. For further details, call 131 031. Proof of receipt of the rebate is required to be produced at the time of the service call.

---

# **SOLAHART HEAT PUMP WATER HEATER WARRANTY - AUSTRALIA ONLY -**

---

## **HEAT PUMP WATER HEATER MODEL 325HAV**

### **4. ENTITLEMENT TO MAKE A CLAIM UNDER THIS WARRANTY**

- 4.1 To be entitled to make a claim under this warranty you need to:
- a) Be the owner of the water heater or have consent of the owner to act on their behalf.
  - b) Contact Solahart without undue delay after detection of the defect and, in any event, within the applicable warranty period.
- 4.2 You are **not** entitled to make a claim under this warranty if your water heater:
- a) Does not have its original serial numbers or rating labels.
  - b) Is not installed in Australia.

### **5. HOW TO MAKE A CLAIM UNDER THIS WARRANTY**

- 5.1 If you wish to make a claim under this warranty, you need to:
- a) Contact Solahart on 1800 638 011 and provide owner's details, address of the water heater, a contact number and date of installation of the water heater or if that's unavailable, the date of manufacture and serial number (from the rating label on the water heater).
  - b) Solahart will arrange for the water heater to be tested and assessed on-site.
  - c) If Solahart determines that you have a valid warranty claim, Solahart will repair or replace the water heater in accordance with this warranty.
- 5.2 Any expenses incurred in the making of a claim under this warranty will be borne by you.

### **6. THE AUSTRALIAN CONSUMER LAW**

- 6.1 Our goods come with guarantees that cannot be excluded under the Australian Consumer Law. You are entitled to a replacement or refund for a major failure and for compensation for any other reasonably foreseeable loss or damage. You are also entitled to have the goods repaired or replaced if the goods fail to be of acceptable quality and the failure does not amount to a major failure.
- 6.2 The Solahart warranty (set out above) is in addition to any rights and remedies that you may have under the Australian Consumer Law.

---

## SAFETY, WARNINGS, INSTALLATION NOTES

---

It is important you read the following **Safety and Warnings**, and **Relief Valves** information.

### SAFETY AND WARNINGS

- The heat pump module will operate until a water temperature of 60°C is reached. If the ambient air temperature is outside of the heat pump's operating range and heating of water is required, a booster electric heating unit will heat the water temperature to 70°C.

These temperatures are sufficiently hot to cause severe scalding. Water at this temperature may have been plumbed to fixtures where water hotter than 50°C is allowed, such as the kitchen and laundry.

Refer to:

- **“Electric Boosting”** on page 10, and
  - **“How Hot Should the Water Be?”** on page 11, and
  - **“Hotter Water Increases the Risk of Scald Injury”** on page 11.
- This water heater is only intended to be operated by persons who have the experience or the knowledge and the capabilities to do so.
  - This water heater is not intended to be operated by persons with reduced physical, sensory or mental capabilities i.e. the infirm, or by children. Children should be supervised to ensure they do not interfere with or play with or at the water heater.
  - If the electrical supply conduit to the water heater is damaged, it must be replaced by a qualified person in order to avoid a hazard. Phone your nearest Solahart Dealer to arrange for an inspection.
  - This water heater uses 220 V - 240 V a.c. electrical power for operation of the control systems and the electrically operated components. The removal of the access covers will expose 220 V - 240 V a.c. wiring. They must only be removed by a qualified person. Do not operate the water heater with any of the covers removed.
  - This water heater is supplied with a thermostat, two over-temperature energy cut-outs and a combination temperature pressure relief valve. These devices must not be tampered with or removed. The water heater must not be operated unless each of these devices is fitted and is in working order.

**The Solahart warranty may not cover faults if relief valves or other safety devices are tampered with or if the installation is not in accordance with these instructions.**

- **DANGER:** The operation of the over-temperature cut-out on the thermostat indicates a possibly dangerous situation. If the over-temperature cut-out operates, it must not be reset and the water heater must be serviced by a qualified person.
- For continued safety of this water heater, it must be installed, operated, and maintained in accordance with the Owner's Guide and Installation Instructions.
- Servicing of the water heater must only be carried out by qualified personnel. Phone your nearest Solahart Dealer.
- The lever on the temperature pressure relief valve and expansion control valve (if fitted) requires to be operated every six (6) months to clear any deposits and to ensure the valve and its drain line are not blocked.

Refer to:

- **“Relief Valves”** on page 8, and
  - **“Minor Maintenance Every Six Months”** on page 15.
- Only a person qualified to install or service a water heater can drain the water heater if this is required.
  - Do not modify this water heater.

- In areas where there is a risk of freezing conditions, power must be available to the water heater at all times and the electrical supply to the water heater should not be switched off, otherwise damage could result.

Refer to:

- “Freeze Protection” on page 11, and
- “To Turn Off the Water Heater” on page 11.
- Do not use **aerosols, stain removers and household chemicals** in the vicinity of this water heater while it is in operation. Gases from some aerosol sprays, stain removers and household chemicals are corrosive to the materials used in the heat pump system.
- Do not store swimming pool chemicals, household cleaners, etc., near the water heater.
- Ensure the air flow, air inlet louvres and outlet grille are not obstructed in any way at any time.

## RELIEF VALVES

### Temperature Pressure Relief Valve

This water heater incorporates a temperature pressure relief valve located near the top of the water heater. This valve is essential for the water heater’s safe operation.

It is possible for the valve to discharge a quantity of water through the drain line during each heating period. This quantity should be equal to approximately 1/50 of the hot water used, as water expands by this volume when heated.

### Expansion Control Valve

In many areas, including South Australia, Western Australia and scaling water areas, it is mandatory an expansion control valve is fitted to the cold water line to the water heater.

The expansion control valve will discharge the quantity of water from its drain line during the heating period instead of the temperature pressure relief valve as it has a lower pressure rating.

### Valve Operation

Continuous leakage of water from either valve and its drain line may indicate a problem with the water heater. Refer to “Temperature Pressure Relief Valve or Expansion Control Valve Running” on page 21.

**⚠ Warning:** Never block the outlet of either valve or their drain lines for any reason. A relief valve drain must be left open to atmosphere and be installed in a continuously downward direction.

In locations where water pipes are prone to freezing, the relief valve drain line must be insulated and not exceed 300 mm in length before discharging into a tundish through an air gap.

Operate the easing lever on the temperature pressure relief valve and expansion control valve once every six (6) months to clear any deposits and ensure the valve and its drain line are not blocked. **It is very important the lever is raised and lowered gently.** Refer to “Minor Maintenance Every Six Months” on page 15.

**⚠ Warning:** Water discharged from the temperature pressure relief valve drain line will be hot. Exercise care to avoid any splashing of water by standing clear of the drain line’s point of discharge when operating either valve’s easing lever.

**⚠ DANGER:** Failure to operate the easing lever on the relief valve once every six (6) months may result in the water heater cylinder failing, or under certain circumstances, exploding.

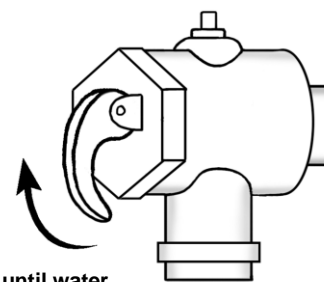
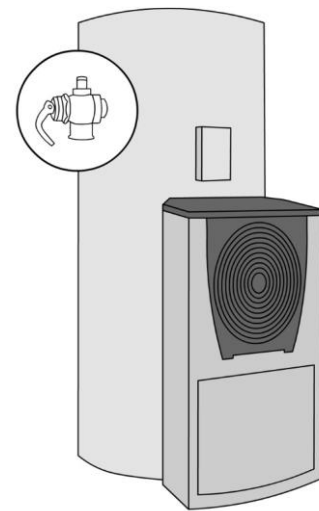

lift until water  
flows from the  
drain line –  
lower gently

outlet /  
drain  
line



If water does not flow freely from the drain line when the lever is lifted, then the water heater must be checked. Phone your nearest Solahart Dealer to arrange for an inspection.

The temperature pressure relief valve should be replaced at intervals not exceeding five (5) years and the expansion control valve should be checked for performance or replaced at intervals not exceeding five (5) years. The checking of the valves performance or replacement should occur more frequently in areas where there is a high incidence of water deposits. Refer to “[Water Supplies](#)” on page 16.

## INSTALLATION NOTES

This water heater must be installed:

- by a qualified person,
- in accordance with the installation instructions,
- in compliance with the Plumbing Code of Australia (PCA) and Plumbing Standard AS/NZS 3500.4,
  - This water heater is designed for outdoor installation only.
  - This water heater is intended to be permanently connected to the water mains and not connected by a hose-set. A braided flexible hose or semi-flexible connector may be used for connection to the water heater, where permitted by AS/NZS 3500.4.
  - Refer to [dimensions diagram](#) on page 28 for clearance requirements to provide adequate ventilation for the heat pump module.
- in compliance with the Australian / New Zealand Wiring Rules AS/NZS 3000,
  - Isolation switches must be installed in the electrical circuit to the water heater in accordance with the Wiring Rules, so the water heater can be switched off.
  - The water heater must be directly connected to the mains power supply. Electrical connections between the heat pump module and storage tank are made using mating connectors fitted to these components.
  - The power supply wires are to be directly connected to the terminal block and earth tab connection, with no excess wire loops inside the front cover. The temperature rating of the power supply wires insulation must suit this application, or the wiring protected by insulating sleeving with an appropriate temperature rating if it can make contact with the internal storage cylinder. The temperature of the internal storage cylinder can reach 70°C under normal operation.
- in compliance with all local codes and regulatory authority requirements.

Installation and commissioning requirements and details for the installing plumber and licensed electrical worker are contained on [pages 23 to 48](#).

### Mains pressure water supply

The water heater is designed to operate at mains pressure by connecting directly to the mains water supply.

The water heater is supplied with a temperature pressure relief valve with a pressure rating of 1000 kPa. If an expansion control valve has been installed on the cold water line to the water heater, this should have a pressure rating of 850 kPa.

The maximum mains water supply pressure for the water heater is 800 kPa if an expansion control valve is not installed, or 680 kPa if an expansion control valve is installed. If the mains supply pressure in your area exceeds these values, a pressure limiting valve must be installed.

A minimum water supply pressure of 200 kPa is required to enable the heat pump circulator and heat pump system to operate effectively.

The supply pressure should be greater than 350 kPa for true mains pressure operation to be achieved.

---

## ABOUT YOUR WATER HEATER

---

### WATER HEATER APPLICATION

This water heater is designed for use in a single family domestic dwelling for the purpose of heating potable water. Its use in an application other than this may shorten its life.

### MODEL TYPE

Your Solahart Atmos<sup>®</sup> air sourced heat pump water heater is designed for outdoor installation only. The model you have chosen is a 325HAV model and is recommended for connection to either a 24 hour continuous tariff or an extended off-peak (minimum 16 hours per day – replacement model and climate dependant) power supply.

A Solahart Atmos heat pump water heater consumes less energy than an electric water heater. The impact on an electricity bill will depend on the tariff arrangement of the water heater replaced and where you live. Contact your energy provider for more information on tariff arrangements and cost comparisons.

The Solahart Atmos air sourced heat pump water heater has a vitreous enamel lined steel cylinder. The water heater's evaporator absorbs heat from the surrounding air and transfers this heat into the water.

When hot water is drawn off and cold water enters the tank, the thermostat activates a fan, a compressor and a circulator. The fan draws outside air in through the air inlet louvres at the side of the heat pump module and the pump circulates water from the bottom of the storage tank through a heat exchanger. Heat is absorbed from the air by an evaporator and transferred into the water through the heat exchanger. The resulting cold air is then discharged through the air outlet grille back to atmosphere and the heated water is circulated back into the storage tank. This process continues while heating is required until the water in the storage tank reaches a temperature of 60°C.

Even on cloudy or cold days, heat is drawn from the surrounding air. The heat pump will operate when the ambient air temperature is between a minimum of 3°C to 5°C and maximum of 45°C to 55°C. The booster heating unit will operate when the ambient air temperature is outside of this temperature range if heating is required. The efficiency of the water heater increases as the ambient air temperature increases within the operating range of the heat pump.

Automatic safety controls are fitted to the water heater to provide safe and efficient operation.

### PRECAUTIONS

The water heater must be maintained in accordance with the Owner's Guide and Installation Instructions. Refer to "[Maintenance Requirements](#)" on page 15 and to "[Anode Inspection and Replacement](#)" on page 16.

If this water heater is to be used where an uninterrupted hot water supply is necessary for your application or business you should ensure that you have back-up redundancy within the hot water system design. This should ensure the continuity of hot water supply in the event that this water heater were to become inoperable for any reason. We recommend you seek advice from a plumber or specifier about your needs and building back-up redundancy into your hot water supply system.

### ELECTRIC BOOSTING

Ice may begin to form on the evaporator reducing the heat pump efficiency, when the ambient air temperature falls below 7°C and the heat pump has been operating for an extended period. At ambient air temperatures below 3°C to 5°C, the water heater deactivates the heat pump operation and switches to the booster heating unit. During this period the evaporator will defrost if necessary.

At ambient air temperatures above 45°C to 55°C, the water heater deactivates the heat pump operation and switches to the booster heating unit.

The temperature setting of the thermostat controlling the booster heating unit is not adjustable and is set at 70°C. The supplied 3.6 kW booster element will heat 180 litres of water inside the tank if heating is required. A booster element of a size or type other than the 3.6 kW element supplied may provide a different boost capacity.

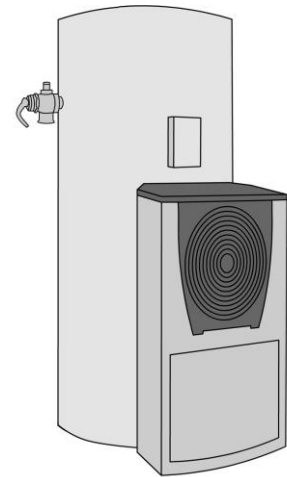

**FREEZE PROTECTION**

The water heater has a freeze protection system. The freeze protection system will protect the water heater from damage, by preventing ice forming in the waterways of the water heater, in the event of freezing conditions occurring.

If the ambient air temperature falls below 1°C and the heat pump is not operating, the system will operate the circulator periodically. During this freeze protection cycle, the circulator will operate for thirty (30) seconds and then rest for fifteen (15) minutes, before the cycle is recommenced. Water is circulated from the storage tank through the heat pump circuit, to prevent freezing in the connecting pipe work and heat pump module. The green LED will flash a series of four (4) flashes whilst the circulator is operating.

The water heater has NO WARRANTY for freeze damage if power is unavailable at the water heater.

**⚠ Warning:** In areas where the ambient air temperature may fall below 1°C, power must be available to the water heater at all times to prevent freezing in the heat pump circuit.

**HOW HOT SHOULD THE WATER BE?**

The system controls (compressor, evaporator and fan) will operate until a water temperature of 60°C is reached. If the ambient air temperature is outside of the heat pump’s operating range, the water temperature is boosted automatically to 70°C by the thermostatically controlled booster electric heating unit, if heating is required.

To meet the requirements of the National Plumbing Standard the temperature of the stored water must not be below 60°C.

**HOTTER WATER INCREASES THE RISK OF SCALD INJURY**

**⚠ Warning:** This water heater can deliver hot water at temperatures up to 70°C, sufficiently hot to cause severe scalding. Water at this temperature may have been plumbed to fixtures where water hotter than 50°C is allowed, such as the kitchen and laundry.

Check the water temperature before use, such as when entering a shower or filling a bath or basin, to ensure it is suitable for the application and will not cause scald injury.

We recommend and it may also be required by regulations that an approved temperature limiting device be fitted into the hot water pipe work to the bathroom and ensuite when this water heater is installed. This will keep the water temperature below 50°C at the bathroom and ensuite. The risk of scald injury will be reduced and still allow hotter water to the kitchen and laundry.

**TEMPERATURE ADJUSTMENT**

The thermostats controlling the heat pump and the booster heating unit are factory set and not adjustable.

**TO TURN OFF THE WATER HEATER**

If you plan to be away from home for only a few nights, we suggest you leave the water heater switched on.

If it is necessary to turn off the water heater:

- Switch off the electrical supply at the water heater isolating switch on the switchboard or at the isolating switch at the water heater.
- Close the cold water isolation valve at the inlet to the water heater.

**Note:** If there is a risk of freezing conditions, the electrical supply to the water heater should not be switched off, otherwise damage could result (refer to “Freeze Protection” on page 11).

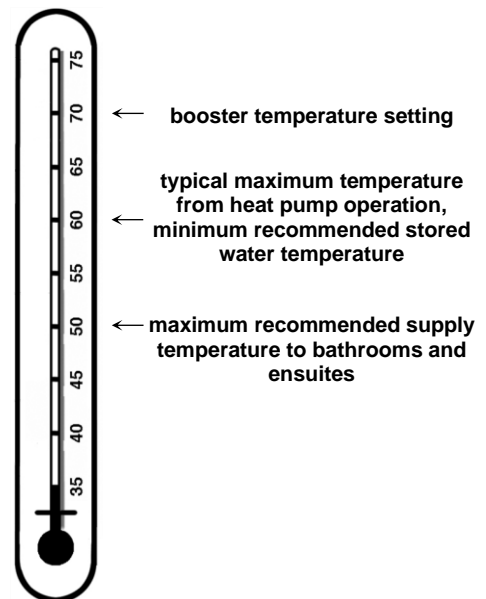

**TO TURN ON THE WATER HEATER**

- Open the cold water isolation valve fully on the cold water line to the water heater.
- Switch on the electrical supply at the water heater isolating switch on the switchboard and at the isolating switch at the water heater.
- Check and if required reset the timer, if one is installed.

When power is turned on or reconnected to the water heater, the green LED will flash rapidly for three (3) seconds. The LED display will then return to the current operational status.

The water heater may take up to forty five (45) minutes to commence operating when the power supply is switched on. The heat pump will only operate when power is available at the water heater, the water in the storage tank requires heating, the heat pump compressor is cool and the ambient air temperature is within the heat pump’s operating temperature range of between a minimum of 3°C to 5°C and a maximum of 45°C to 55°C. If the ambient temperature is outside of this range, the water heater will commence heating with the booster heating unit.

When the heat pump is operating, the system will switch to the booster heating unit if the detected ambient air temperature is outside the operating temperature range of between a minimum of 3°C to 5°C and a maximum of 45°C to 55°C.

The system will not switch back to heat pump operation from the booster heating unit if the detected ambient air temperature has moved back within the heat pump’s operating temperature range. The heating cycle will be completed by the booster heating unit.

**Note:** The heat pump may not turn on immediately after either having just completed a heating cycle and more hot water is drawn from the water heater or power is shut down to the compressor, either during or at the end of a heating cycle. The heat pump will wait until the compressor has cooled down and the conditions for start-up are favourable in order to protect the compressor from damage. This will be a minimum of forty five (45) minutes and may take up to ninety (90) minutes from the last heating cycle.

**OPERATING MODE MONITOR**

An operating mode monitor is located on the front of the heat pump module and houses a green and a red LED. The green LED, marked “NORMAL”, indicates the current operating mode of the heat pump water heater and the red LED, marked “ATTENTION”, indicates a fault mode.

The green LED will emit either a constant glow or a series of flashes, with a two (2) second interval between each series. A series of long green flashes may also be emitted.

The red LED will emit a series of flashes, with a two (2) second interval between each series, only if there is a particular fault condition with the system.

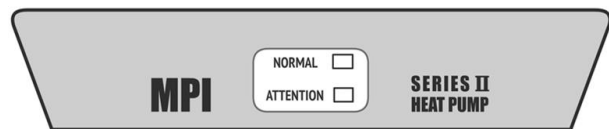

The modes are:

Green LED	Red LED	Operational Modes
solid green (remains on)	off	Standby mode – water is hot
1 x green	off	Call for heating received – system checks performed Note: unit may wait and continue flashing until compressor has cooled from its last operation
2 x green	off	Heat pump preheating
3 x green	off	Heat pump operation – compressor and fan running
4 x green	off	Freeze protection operation – circulator on
long green	off	Heating unit on – ambient air temperature below 3°C to 5°C or above 45°C to 55°C
rapid green	off	System start-up – heating unit on
no green (remains off)	off	No power at the water heater or to the heat pump or a possible fault condition <b>Refer to notes overleaf before calling for service</b>

## Notes

- **Power must be available at the water heater and to the heat pump for the LEDs to glow or flash.**
- **Time controlled power supply (power must be available at the water heater)**  
If the water heater is connected to a time controlled power supply, then during periods of no power supply at the water heater the LEDs will be off.

This is not a fault condition, but a result of no power being available to energise the LEDs.

The green LED will recommence glowing or flashing when power is available again at the water heater.

- **Heat pump operating range (power must be available to the heat pump)**  
The heat pump's operating range is between an ambient air temperature of a minimum of 3°C to 5°C and a maximum of 45°C to 55°C. The heat pump will not operate when the ambient air temperature is outside the heat pump's operating range.

If heating is required, the water heater will commence heating with the booster heating unit in booster heating mode (long green flash) instead. The water will be heated to 70°C during these periods.

At the completion of this heating cycle by the booster heating unit (long green flash), the thermostat controlling the booster heating unit opens circuit cutting power to the heat pump causing the green LED to go out. This is not a fault condition, but a result of the power being cut to the heat pump by the thermostat.

Refer to "**Heat pump operating range**" on page 19 in the "Save A Service Call" section of this Owner's Guide for further explanation.

- **Possible fault condition – Green LED is off or red LED is flashing**  
If there is power to the water heater and the green LED is off or the red LED is flashing, this indicates there may be a fault condition with the water heater. The red LED may emit up to nine flashes in each series of flashes.

There may be a fault condition with the water heater if either:

- there is power available at the water heater and the green LED is off, and
- the water heater **has not** operated outside of the heat pump's operating range – refer to "**Heat pump operating range**" on page 19.

Before phoning to arrange a service inspection due to the green LED being off, refer to "**Heat Pump Is Not Operating**" on page 19 in the "Save A Service Call" section of this Owner's Guide.

or

- the red LED is flashing – the red LED may emit up to nine flashes in each series of flashes

The fault condition which led to the red LED flashing may be cleared after the backup heating cycle by the booster heating unit has completed. When heating is next required the red LED will recommence to flash the fault code for 27 seconds and then extinguish. If the red LED then recommences to flash or recommences to flash after the heat pump next operates, a service call may be required.

Before phoning to arrange a service inspection due to the red LED flashing, refer to "**Heat Pump Is Not Operating**" on page 19 in the "Save A Service Call" section of this Owner's Guide.

### **TIMER CONTROL**

A timer can be installed in the electrical circuit to the water heater. The timer must be weatherproof if it is installed outdoors.

It may be desirable for the water heater not to operate between certain hours, such as during the peak period when connected to a Time of Use electricity supply due to a more expensive tariff rate applying.

A timer will affect the operating times of both the heat pump circuit and the booster heating unit.

### **Notes**

- The 325HAV model water heater is recommended for connection to either a 24 hour continuous tariff or an extended off-peak (minimum 16 hours per day – replacement model and climate dependant) power supply.
- If there is a risk of freezing conditions, the electrical supply to the water heater should not be switched off, otherwise damage could result (refer to **“Freeze Protection”** on page 11).

### **GOING ON HOLIDAYS**

If you plan to be away from home for a few nights, we suggest you leave the water heater switched on. If you plan to be away for a longer period, conserve energy by switching off the isolating switch to the water heater. It is not advised to switch off the water heater if there is the risk of freeze conditions. Refer to **“To Turn Off The Water Heater”** on page 11.

### **VICTORIAN CUSTOMERS**

Notice to Victorian Customers from the Victorian Building Authority. This water heater must be installed by a licensed person as required by the Victorian Building Act 1993.

Only a licensed person will give you a Compliance Certificate, showing that the work complies with all the relevant Standards. Only a licensed person will have insurance protecting their workmanship for 6 years. Make sure you use a licensed person to install this water heater and ask for your Compliance Certificate.

### **DOES THE WATER CHEMISTRY AFFECT THE WATER HEATER?**

The water heater is suitable for most public water supplies, however some water chemistries may have detrimental effects on the water heater, its components and fittings. Refer to **“Water Supplies”** on page 16.

If you are in a known harsh water area or you are not sure of your water chemistry, have your water checked against the conditions **described on pages 16 to 17**.

### **HOW LONG WILL THE WATER HEATER LAST?**

The water heater is supported by a manufacturer’s warranty (**refer to page 4**). There are a number of factors that will affect the length of service the water heater will provide. These include but are not limited to the water chemistry, the water pressure, the water temperature (inlet and outlet) and the water usage pattern. Refer to **“Precautions”** on page 10.

### **ENVIRONMENT**

At the end of the service life of the heat pump water heater and prior to the water heater being disposed of, a person qualified to work with refrigerants must recover the refrigerant from within the sealed system. The refrigerant must not be vented to atmosphere. Phone your nearest Solahart Dealer to arrange for an inspection.

---

## MAINTENANCE REQUIREMENTS

---

### MINOR MAINTENANCE EVERY SIX MONTHS

It is recommended minor maintenance be performed every six (6) months. Minor maintenance can be performed by the dwelling occupant.

The minor maintenance includes:

- Operate the easing lever on the temperature pressure relief valve. **It is very important the lever is raised and lowered gently.** Refer to “Relief Valves” on page 8.

**⚠ Warning:** Water discharged from the temperature pressure relief valve drain line will be hot. Exercise care to avoid any splashing of water by standing clear of the drain line’s point of discharge when operating the valve’s easing lever.

- Operate the easing lever on the expansion control valve (if fitted). **It is very important the lever is raised and lowered gently.** Refer to “Relief Valves” on page 8.

### MAJOR SERVICE EVERY FIVE YEARS

It is recommended a major service be conducted on the water heater every five (5) years.

**⚠ Warning:** Servicing of a water heater must only be carried out by qualified personnel. Phone your nearest Solahart Dealer.

**Note:** The major service and routine replacement of any components, such as the anode and relief valve(s), are not included in the Solahart warranty. A charge will be made for this work. Only genuine replacement parts should be used on this water heater.

The major service includes:

- Replace the temperature pressure relief valve.
- Inspect and flush the expansion control valve (if fitted). If required, replace the valve.
- Inspect and if required, replace the anode.

If the anode is not replaced, it should be replaced within three (3) years of this service (refer to “Anode Inspection and Replacement” on page 16).

- Check the electric heating unit for excessive calcium build-up or corrosion and replace if necessary.
- Check and inspect the heat pump module for operation.
- Visually check the unit for any potential problems.
- Inspect all connections.
- Check the condensate drain.

**Note:** The water heater may need to be drained during this service. After the completion of the service, the water heater will take some time to reheat the water. Depending upon the power supply connection, hot water may not be available until the next day.

### HEAT PUMP SYSTEM

It is recommended the evaporator and refrigeration system is checked every five (5) years. In particularly dusty environments, it may be necessary to have the heat pump system checked and cleaned of dust and residue on a more regular basis.



---

## WATER SUPPLIES

---

**This water heater must be installed in accordance with this advice to be covered by the Solahart warranty.**

This water heater is manufactured to suit the water conditions of most public reticulated water supplies. However, there are some known water chemistries which can have detrimental effects on the water heater and its operation and / or life expectancy. If you are unsure of your water chemistry, you may be able to obtain information from your local water supply authority. This water heater should only be connected to a water supply which complies with these guidelines for the Solahart warranty to apply.

### CHANGE OF WATER SUPPLY

The changing or alternating from one water supply to another can have a detrimental effect on the operation and / or life expectation of a number of components in this water heater.

Where there is a changeover from one water supply to another, e.g. a rainwater tank supply, bore water supply, desalinated water supply, public reticulated water supply or water brought in from another supply, then water chemistry information should be sought from the supplier or it should be tested to ensure the water supply meets the requirements given in these guidelines for the Solahart warranty to apply.

### ANODE

The vitreous enamel lined cylinder of the water heater is only covered by the Solahart warranty when the total dissolved solids (TDS) content in the water is less than 2500 mg/L and when the correct colour coded anode is used. If an incorrect colour coded anode is used in the water heater, any resultant faults will not be covered by the Solahart warranty. In addition, the use of an incorrect colour coded anode may shorten the life of the water heater cylinder.

The correct colour coded anode is as shown in the following table:

Total Dissolved Solids	Anode colour code
0 – 40 mg/L	Green
40 – 150 mg/L	Green or Black
150 – 400 mg/L	Black
400 – 600 mg/L	Black or Blue
600 – 2500 mg/L	Blue
2500 mg/L +	Blue (no cylinder warranty)

The changing of anodes must be carried out by a qualified person.

**Note:** Some water analysis reports may state the conductivity of the water rather than the level of total dissolved solids. Conductivity, measured in microsiemens per centimetre ( $\mu\text{S} / \text{cm}$ ), is directly proportional to the TDS content of the water. TDS, in mg / L, is approximately 70% of the conductivity in  $\mu\text{S} / \text{cm}$ .

### ANODE INSPECTION AND REPLACEMENT

The anode installed in your water heater will slowly dissipate whilst protecting the cylinder. The life of the cylinder may be extended by replacing the anode.

For water supplies which are either softened or desalinated, or where the water supply may alternate between a water tank and a reticulated public supply or another supply, or where there is a variable supply (e.g. from a bore or public reticulated supply from various water sources), the anode must be inspected (and replaced if there is any sign of depletion) within five (5) years of its installation.

For all water supplies, if the anode is not replaced during a major service (refer to “Major Service Every Five Years” on page 15) then the maximum time after installation when the anode should be replaced for this water heater is eight (8) years.



**CAUTION**

If the water supply has a TDS greater than 150 mg/L and a green anode has not been changed to a black anode, or if the TDS is greater than 600 mg/L and the anode has not been changed to a blue anode, there is the possibility the anode may become overactive and hydrogen gas could accumulate in the top of the water heater during long periods of no use.

If, under these conditions, the water heater has not been used for two or more weeks the following procedure should be carried out before using any electrical appliances (automatic washing machines and dishwashers) which are connected to the hot water supply.

The hydrogen, which is highly flammable, should be vented safely by opening a hot tap and allowing the water to flow. There should be no smoking or naked flame near the tap whilst it is turned on. Any hydrogen gas will be dissipated. This is indicated by an unusual spurting of the water from the tap. Once the water runs freely, any hydrogen in the system will have been released.

**SATURATION INDEX**

The saturation index (SI) is used as a measure of the water's corrosive or scaling properties. The saturation index figures stated are calculated using a water temperature of 80°C.

Where the saturation index is less than -1.0, the water is very corrosive and the Solahart warranty does not apply to the water heater. In a corrosive water supply, the water can attack copper parts and cause them to fail.

Where the saturation index exceeds +0.40, the water is very scaling and the Solahart warranty does not apply to the water heater.

Water which is scaling may be treated with a water softening device to reduce the saturation index of the water.

**CHLORIDE AND PH**

Where the chloride level exceeds 250 mg/L the Solahart warranty does not apply to the water heater. In a high chloride water supply, the water can corrode stainless steel parts and cause them to fail.

Where the pH is less than 6.0 the Solahart warranty does not apply to the water heater. pH is a measure of whether the water is alkaline or acid. In an acidic water supply, the water can attack stainless steel parts and cause them to fail.

Water with a pH less than 6.0 may be treated to raise the pH. The water supply from a rainwater tank in a metropolitan area is likely to be corrosive due to the dissolution of atmospheric contaminants.

**SUMMARY OF WATER CHEMISTRY ADVICE AFFECTING WARRANTY**

The water heater is not suitable for certain water chemistries. Those chemistries are listed below. If the water heater is connected at any time to a water supply with the following water chemistry, the Solahart warranty will not cover any resultant faults:

<b>Water Chemistry</b>	<b>Component</b>
Total Dissolved Solids (TDS) > 2500 mg/L	water heater cylinder
Total Dissolved Solids (TDS) not suitable for anode type	water heater cylinder
Saturation Index (SI) < -1.0	water heater
Saturation Index (SI) > +0.4	water heater
Chloride > 250 mg/L	water heater
pH < 6.0	water heater

---

## SAVE A SERVICE CALL

---

Check the items below before making a service call. You will be charged for attending to any condition or fault that is not related to manufacture or failure of a part.

### NOT ENOUGH HOT WATER (OR NO HOT WATER)

- **Is the electricity switched on?**

Inspect the isolating switch marked “HOT WATER” or “WATER HEATER” at the switchboard and the isolating switch at the water heater and ensure they are turned on.

Check the fuse or circuit breaker marked “HOT WATER” or “WATER HEATER” at the switchboard.

- **Is a timer installed?**

If a timer has been installed, ensure sufficient time has been allowed to reheat the storage tank.

- **Are you using more hot water than you think?**

Is one outlet (especially the shower) using more hot water than you think?

Very often it is not realised the amount of hot water used, particularly when showering. Carefully review the family's hot water usage. As you have installed an energy saving appliance, energy saving should also be practised in the home.

Adjust your water usage pattern to take advantage of maximum energy gains. Have a plumber install a flow control valve to each shower outlet to reduce water usage.

- **Heat pump fault**

Has the heat pump developed a fault and the red LED is flashing?

The heat pump will not operate and the water heater may switch to backup heating mode using the booster heating unit.

Refer to “[Heat Pump Is Not Operating](#)” on page 19.

- **Relief valve running**

Is the relief valve discharging too much water?

Refer to “[Temperature Pressure Relief Valve or Expansion Control Valve Running](#)” on page 21.



### WATER NOT HOT ENOUGH

You may find that due to heavy hot water usage the water temperature may be lower than normally expected, due to insufficient heating time being allowed. You will need to carefully plan your use of the hot water on such occasions.

### WATER TOO HOT

The water heater during heat pump operation will heat the water to a temperature of 60°C. In booster heating mode or back up heating mode the water will be heated to 70°C. The heat pump will operate when the ambient air temperature is between a minimum of 3°C to 5°C and maximum of 45°C to 55°C. The booster heating unit will operate in booster heating mode when the ambient air temperature is outside of this temperature range, if heating is required. This is normal operation.

If a heat pump component has developed a fault condition, the heat pump will not operate and the water heater will switch to backup heating mode to ensure a supply of hot water. In backup heating mode, the booster heating unit will operate if heating of the water is required, regardless of the ambient air temperature. The red LED will flash to indicate the fault mode that has occurred. Refer to “[Heat Pump Is Not Operating](#)” on page 19.

## HEAT PUMP IS NOT OPERATING

There must be power available at the water heater and to the heat pump for the heat pump to operate and for the LEDs to glow or flash.

- **Time controlled power supply – no power at the water heater (green and red LEDs are off)**

If the water heater is connected to a time controlled power supply, then during periods of no power supply at the water heater the LEDs will be off.

This is not a fault condition, but a result of no power being available to energise the LEDs.

Check the hours of supply from the electricity retailer or the timer settings if one is installed.

The green LED will recommence glowing or flashing when power is available again at the water heater.

- **Heat pump operating range**

The heat pump's operating range is between an ambient air temperature of a minimum of 3°C to 5°C and a maximum of 45°C to 55°C. The heat pump will not operate when the ambient air temperature is outside the heat pump's operating range.

If heating is required, the water heater will commence heating with the booster heating unit in booster heating mode (long green flash) instead. The water will be heated to 70°C during these periods.

At the completion of this heating cycle by the booster heating unit (long green flash), the thermostat controlling the booster heating unit opens circuit cutting power to the heat pump causing the green LED to go out.

This is not a fault condition, but a result of the power being cut to the heat pump by the thermostat.

The green LED will remain off for an extended period of time until the water temperature in the top of the water heater drops to below 62°C and the thermostat closes circuit reinstating power to the heat pump. The green LED will then flash rapidly for three (3) seconds before recommencing to glow or emit a series of single flashes.

The green LED will glow (standby mode – water is hot) if the water temperature in the lower part of the water heater is 50°C or more.

The green LED will flash if the water temperature in the lower part of the water heater is less than 50°C. If the ambient air temperature has moved back to within the heat pump's operating range, heating of the water by the heat pump will recommence (3 x green flashes). It may take up to forty five (45) minutes for the heat pump to start-up depending upon when it last operated. If the ambient air temperature is outside of the heat pump's operating range, the water heater will switch to the booster heating unit (long green flash).

- **Green LED is off**

There may be a fault condition with the heat pump if:

- there is power available at the water heater and the green LED is off, and
- the water heater **has not** operated outside of the heat pump's operating range – refer to "**Heat pump operating range**" on page 19.

Before phoning to arrange a service inspection:

- inspect the isolating switch marked "HOT WATER" or "WATER HEATER" at the switchboard and the isolating switch at the water heater and ensure they are turned on
- check the fuse marked "HOT WATER" or "WATER HEATER" at the switchboard
- if a timer has been installed, check the time settings
- check the power supply tariff the water heater is connected to and confirm whether power should be available to the water heater.

If the green LED is off and one of these conditions is not the cause, refer also to "**Possible fault condition**" on page 20.

- **Possible fault condition (1 or 3 to 9 x red flashes)**

If the heat pump has developed a fault, the heat pump will not operate, the red LED will flash a fault mode of a series of either one (1) or three (3) to nine (9) flashes.

If a single flash or a series of three (3) to eight (8) red flashes occurs, the water heater will switch to backup heating mode to ensure a supply of hot water.

Refer to **“Backup heating mode and series of red flashes”** on page 20.

If a series of nine (9) red flashes occurs, the heat pump will not switch to backup heating mode. Phone your nearest Solahart Dealer to arrange for an inspection.

- **Backup heating mode and series of red flashes (1 or 3 to 8 x red flashes)**

During the backup heating mode by the booster heating unit, caused by a possible heat pump fault condition, the red LED will emit a series of flashes. Count the number of flashes.

At the completion of a heating cycle by the booster heating unit in the backup heating mode and the water temperature reaches 70°C, the thermostat controlling the booster heating unit opens circuit cutting power to the heat pump causing the red LED to go out. The fault mode is recorded to the heat pump controller's memory. The fault condition which led to the red LED flashing may be cleared when the backup heating cycle is completed.

Both LEDs will remain off for an extended period of time until the water temperature in the top of the water heater drops to below 62°C and the thermostat closes circuit reinstating power to the heat pump.

The green LED will flash rapidly for three (3) seconds and then extinguish. The red LED will then recommence to flash the fault mode for 27 seconds and then extinguish.

If the red LED then recommences to flash after the 27 second period, the fault condition which led to the red LED flashing may not have cleared and there may be a problem with the heat pump. Count the number of red flashes and phone Your nearest Solahart Dealer to arrange for an inspection.

If the green LED recommences to glow or flash after the 27 second period, the fault condition may have cleared.

The green LED will glow (standby mode – water is hot) if the water temperature in the lower part of the water heater is 50°C or more.

The green LED will flash if the water temperature in the lower part of the water heater is less than 50°C.

**Note:** If the green LED is glowing, then to check whether there may be a problem with the heat pump, open a hot tap and allow to run for ten to fifteen minutes. This will draw cold water into the lower part of the water heater and the green LED will commence to flash. Close the hot tap when the green LED commences to flash.

The heat pump will commence to operate after the green LED starts flashing. It may take up to forty five (45) minutes for the heat pump to start-up depending upon when it last operated.

If the heat pump stops operating and the red LED recommences to flash, the fault condition which led to the red LED flashing may not have cleared and there may be a problem with the heat pump. Count the number of red flashes and phone Your nearest Solahart Dealer to arrange for an inspection.

**Note:** If the ambient air temperature is outside of the heat pump's operating range, the water heater may switch to the booster heating unit (long green flash) to heat the water in booster heating mode.

The fault mode is cleared from the heat pump controller's memory after the water heater successfully completes a full heat up cycle using the heat pump.

**TEMPERATURE PRESSURE RELIEF VALVE OR EXPANSION CONTROL VALVE RUNNING**

- **Normal Operation**

It is normal and desirable the temperature pressure relief valve or expansion control valve (if fitted) allows a quantity of water to escape during the heating cycle. This quantity should be equal to approximately 1/50 of the hot water used, as water expands by this volume when heated. However, if it discharges more than a bucket full of water in 24 hours, there may be another problem.

The expansion control valve (if fitted) will discharge water instead of the temperature pressure relief valve as it has a lower pressure rating. A benefit is that energy is conserved as the discharged water is cooler. This valve is installed in the cold water line to the water heater (refer to the **cold water connection diagram** on page 40).

- **Continuous dribble**

Try gently raising the easing lever on the relief valve for a few seconds (refer to **"Relief Valves"** on page 8). This may dislodge a small particle of foreign matter and clear the fault. Release the lever gently.

- **Steady flows for long period (often at night)**

This may indicate the mains water pressure sometimes rises above the designed pressure of the water heater. Ask your installing plumber to fit a pressure limiting valve.

**⚠ Warning:** Never replace the relief valve with one of a higher pressure rating.

- **Heavy flows of hot water from the temperature pressure relief valve until water heater is cold - then stops until water reheats**

The water heater **must** be switched off at the switchboard. Phone your nearest Solahart Dealer to arrange for an inspection.

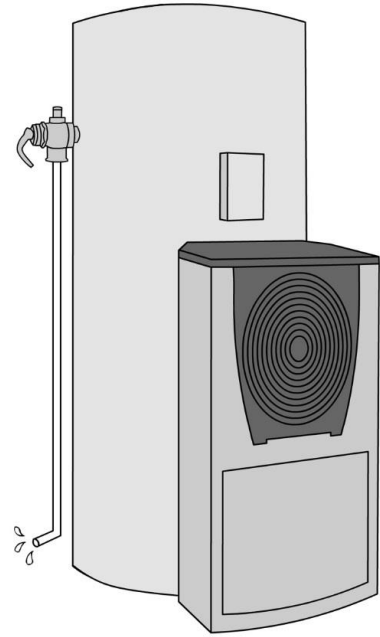

### HIGHER THAN EXPECTED ELECTRICITY BILLS

With the installation of your new air sourced heat pump water heater, maximum electrical energy savings can be achieved. Should you at any time, feel your electricity bill is higher than expected, we suggest you check the following points:

- Is the water heater operating in backup heating mode with the red LED flashing?

If there is a fault condition with the heat pump system, the water heater will default to backup heating mode to ensure a supply of hot water. Check to see if the red LED is flashing as this will indicate there may be a fault with the system.

Refer to **“Heat Pump Is Not Operating”** on page 19.

- Is the relief valve running excessively?

Refer to **“Temperature Pressure Relief Valve or Expansion Control Valve Running”** on page 21.

- Is one outlet (especially the shower) using more hot water than you think?

Refer to **“Not Enough Hot Water”** on page 18.

- Is there a leaking hot water pipe, dripping hot water tap, etc?

Even a small leak will waste a surprising quantity of hot water and energy. Replace faulty tap washers, and have a plumber rectify any leaking pipe work.

- Has there been an increase in hot water usage?

An increase in hot water usage will result in an increase in heat pump operation.

- Has your water heating tariff rate been increased by your electricity retailer since your previous bill?

- Is the heat pump water heater on the same tariff as the water heater replaced?

The impact on an electricity bill will depend upon the tariff arrangement of the water heater replaced and where you live. Contact your energy provider for more information on tariff arrangements and cost comparisons.

- Prolonged periods of use when the ambient air temperature is outside of the heat pumps operating range will increase the amount of boosting and increase running costs.

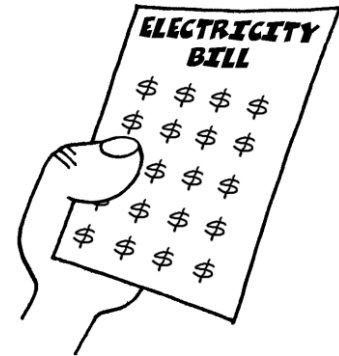

**IF YOU HAVE CHECKED ALL THE FOREGOING AND STILL BELIEVE YOU NEED ASSISTANCE, PHONE YOUR NEAREST SOLAHART DEALER.**

---

# INSTALLATION

---

**THIS WATER HEATER IS FOR OUTDOOR INSTALLATION ONLY.  
THIS WATER HEATER IS NOT SUITABLE FOR POOL HEATING.**

## INSTALLATION STANDARDS

The water heater must be installed:

- by a qualified person, and
- in accordance with the installation instructions, and
- in compliance with the Plumbing Code of Australia (PCA), Standards AS/NZS 3500.4 and AS/NZS 3000, and all local codes and regulatory authority requirements.

**⚠ Warning:** This water heater may deliver water at high temperature. Refer to the Plumbing Code of Australia, local requirements and these installation instructions to determine if additional delivery temperature control is required. Refer to **“Hot Water Delivery”** on page 25.

## Victorian Installers

Notice to Victorian Installers from the Victorian Plumbing Industry Commission if this solar water heater is installed in a new Class 1 dwelling in the State of Victoria. The system model number is to be recorded on the Certificate of Compliance.

It is also a requirement to provide the householder with permanent documentation recording the system model number exactly as it is shown in the ‘VEET Product Register’ published by the Essential Services Commission in Victoria. See [www.veu-registry.vic.gov.au/Public/ProductRegistrySearch.aspx](http://www.veu-registry.vic.gov.au/Public/ProductRegistrySearch.aspx). This documentation may be in the form of an indelible label adhered to the heat pump storage tank, or other suitable form placed in an accessible location, such as the meter box, for later inspection.

## WATER HEATER APPLICATION

This water heater is designed for use in a single family domestic dwelling for the purpose of heating potable water. Its use in an application other than this may shorten its life.

If this water heater is to be used where an uninterrupted hot water supply is necessary for the application or business, then there should be back-up redundancy within the hot water system design. This should ensure the continuity of hot water supply in the event that this water heater was to become inoperable for any reason. We recommend you provide advice to the system owner about their needs and building back-up redundancy into the hot water supply system.

The 325HAV model water heater is recommended for connection to either a 24 hour continuous tariff or an extended off-peak (minimum 16 hours per day – replacement model and climate dependant) power supply. If replacing an electric water heater greater than 250 litres, heat pump connection to a 24 hour continuous tariff is recommended.

A Solahart Atmos heat pump water heater consumes less energy than an electric water heater. The impact on an electricity bill will depend on the tariff arrangement of the water heater replaced and the installation location. Contact the energy provider for more information on tariff arrangements and cost comparisons.

## STORAGE TANK AND HEAT PUMP MODULE

The heat pump water heater is made of two main components, the storage tank and the heat pump module. For transport and handling (weight) purposes both items are shipped separately and designed to be assembled at the installation site. The water heater must not be operated until both components are assembled. Refer to **“Heat Pump and Tank Assembly”** on page 30.

**Care must be taken during transportation and handling. Do not lay the heat pump module down and do not tilt the heat pump module or the heat pump and storage tank assembly more than 30° from the vertical.** This will displace the compressor lubricating oil. If the heat pump module or heat pump and storage tank assembly has been tilted more than 30° from the vertical during handling, it will need one hour to drain back before the power to the water heater can be switched on, otherwise damage to the compressor may result.



Take care when handling the heat pump module. The jacket of the heat pump module needs to be handled gently so as not to cause damage.

All packaging materials must be removed from the water heater prior to its installation. This includes the removal of the cardboard base of the carton from the underside of the water heater.

### WATER HEATER LOCATION

The water heater is suitable for outdoor installation only. The water heater should be installed close to the most frequently used outlet and its position chosen with noise, safety and service in mind. Make sure people (particularly children) will not accidentally touch the air inlet louvres and outlet grille and that they are clear of obstructions and shrubbery.

It is advisable to install the water heater away from bedroom or living room windows as the system controls can generate a level of noise whilst they are operating. Consider the location in relation to neighbours' bedrooms and living room windows.

Clearance must be allowed for servicing of the water heater. The water heater must be accessible without the use of a ladder or scaffold. Make sure the temperature pressure relief valve lever is accessible and the top and front covers, system controls and thermostat can be removed for service.

You must be able to read the information on the rating plate. If possible leave headroom of one water heater height so the anodes can be inspected or replaced. Remember you may have to remove the entire water heater later for servicing.



The water heater is to be installed at ground or floor level and must stand vertically upright on a stable base, as acceptable to local authorities, of a minimum size 900 mm wide x 650 mm deep. The heat pump module must be fully supported by the stable base.

The base of the water heater is made of corrosion resistant material, and it may be placed directly in contact with the supporting surface. It is not necessary to allow for free air circulation under the base of the water heater.

**Note:** The water heater should not be placed in direct contact with a concrete surface that is less than two months old and not fully cured as this may attack the metal coating of the water heater base. A moisture barrier should be used between the two surfaces in this instance. The barrier should extend at least 100 mm from the water heater and may be trimmed after two months.

The water heater must be installed with a clearance of at least 100 mm from a wall. A clearance of at least 300 mm is required perpendicular from both the front air inlet louvres and the outlet grille to any wall or obstruction. Refer to the [dimensions diagram](#) on page 28.

The water heater must not be installed in an area with a corrosive atmosphere where chemicals are stored or where aerosol propellants are released, as exposure to the corrosive atmosphere may attack the materials used in the water heater and heat pump system.

### FREEZE PROTECTION

The water heater has a freeze protection system. The freeze protection system will protect the water heater from damage, by preventing ice forming in the waterways of the water heater, in the event of freezing conditions occurring.

If the ambient air temperature falls below 1°C and the heat pump is not operating, the system will operate the circulator periodically. During this freeze protection cycle, the circulator will operate for thirty (30) seconds and then rest for fifteen (15) minutes, before the cycle is recommenced. Water is circulated from the storage tank through the heat pump circuit, to prevent freezing in the connecting pipe work and heat pump module. The green LED will flash a series of four (4) flashes whilst the circulator is operating.

**⚠ Warning:** In areas where the ambient air temperature may fall below 1°C, power must be available to the water heater at all times to prevent freezing in the heat pump circuit. The water heater has **NO WARRANTY** for freeze damage if power is unavailable at the water heater.



**MAINS WATER SUPPLY**

Where the mains water supply pressure exceeds that shown in the table below, an approved pressure limiting valve is required and should be fitted as shown in the **cold water connection diagram** on page 40.

Model	325
Temperature pressure relief valve setting	1000 kPa
Expansion control valve setting *	850 kPa
Maximum mains supply pressure	
With expansion control valve	680 kPa
Without expansion control valve	800 kPa
Minimum mains supply pressure	200 kPa

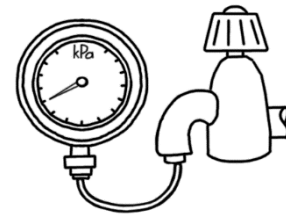

\* Expansion control valve not supplied with the water heater.

**TANK WATER SUPPLY**

If the water heater is supplied with water from a tank supply and a minimum water supply pressure of 200 kPa at the water heater cannot be achieved, then a pressure pump system must be installed to allow the heat pump circulator to operate and avoid air locks in the circuit. Care must be taken to avoid air locks. The cold water line from the supply tank should be adequately sized and fitted with a full flow gate valve or ball valve.

**HOT WATER DELIVERY**

**⚠ Warning:** This water heater can deliver hot water at temperatures up to 70°C, sufficiently hot to cause severe scalding. Water at this temperature may be plumbed to fixtures where water hotter than 50°C is allowed, such as the kitchen and laundry.

The installing plumber may have a legal obligation to ensure the installation of this water heater meets the water temperature delivery requirements of the Plumbing Code of Australia so that heated water delivered to fixtures and appliances used primarily for personal hygiene is at a temperature which is unlikely to scald.

It is necessary and we recommend that a temperature limiting device be fitted between the water heater and the fixtures and appliances used primarily for personal hygiene such as in a bathroom, ensuite, public amenities or other ablution areas, to reduce the risk of scalding.

The temperature limiting device must be of a type suitable for use with a heat pump water heater and should have a specified 'minimum temperature differential' between the hot water inlet and the tempered water outlet of no greater than 10°C. Refer to the specifications of the temperature limiting device.

Where a temperature limiting device is installed adjacent to the water heater, the cold water line to the temperature limiting device can be branched off the cold water line either before or after the isolation valve, pressure limiting valve and non-return valve to the water heater. If an expansion control valve is required, it must always be installed after the non-return valve and be the last valve prior to the water heater.

If a pressure limiting valve is installed on the cold water line to the water heater and the cold water line to a temperature limiting device branches off before this valve or from another cold water line in the premises, then a pressure limiting valve of an equal pressure setting may be required prior to the temperature limiting device.

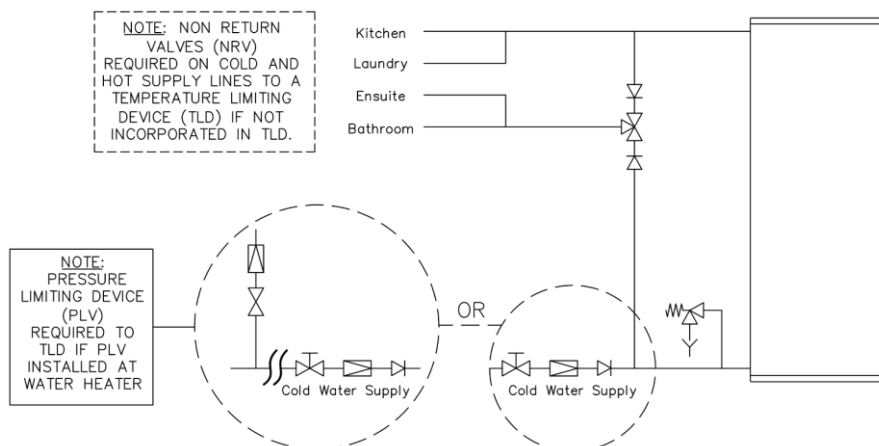

**Two Temperature Zones Using a Temperature Limiting Device**

**CIRCULATED HOT WATER FLOW AND RETURN SYSTEM**

A 325HAV heat pump water heater should not be installed as part of a circulated hot water flow and return system in a building.

If a circulated flow and return system is required, it is necessary to install a secondary water heater supplied from the heat pump water heater. The flow and return lines connect to the secondary water heater, not the heat pump storage tank. The secondary water heater makes up for the pipe heat loss in the flow and return system and must be able to provide a hot water outlet temperature of at least 60°C.

**Note:** The thermostat or preset outlet temperature of the secondary water heater must always be set to maintain a temperature of at least 60°C in the hot water flow and return line, including making up pipe heat losses in the system.

Refer to the diagram **Circulated Hot Water Flow and Return System – Heat Pump Water Heater** on page 26.

**Temperature Limiting Device**

A temperature limiting device cannot be installed in circulated hot water flow and return pipe work. The tempered water from a temperature limiting device cannot be circulated. Where a circulated hot water flow and return system is required in a building, a temperature limiting device can only be installed on a dead leg, branching off the circulated hot water flow and return pipe.

If circulated tempered water were to be returned back to the water heater, depending on the location of the return line connection on the water supply line to the water heater, then either:

- water will be supplied to the cold water inlet of the temperature limiting device at a temperature exceeding the maximum recommended water supply temperature, or
- when the hot taps are closed no water will be supplied to the cold water inlet of the temperature limiting device whilst hot water will continue to be supplied to the hot water inlet of the temperature limiting device.

These conditions may result in either water at a temperature exceeding the requirements of AS/NZS 3500.4 being delivered to the hot water outlets in the ablution areas, or the device closing completely and not delivering water at all, or the device failing. Under either condition, the operation and performance of the device cannot be guaranteed.

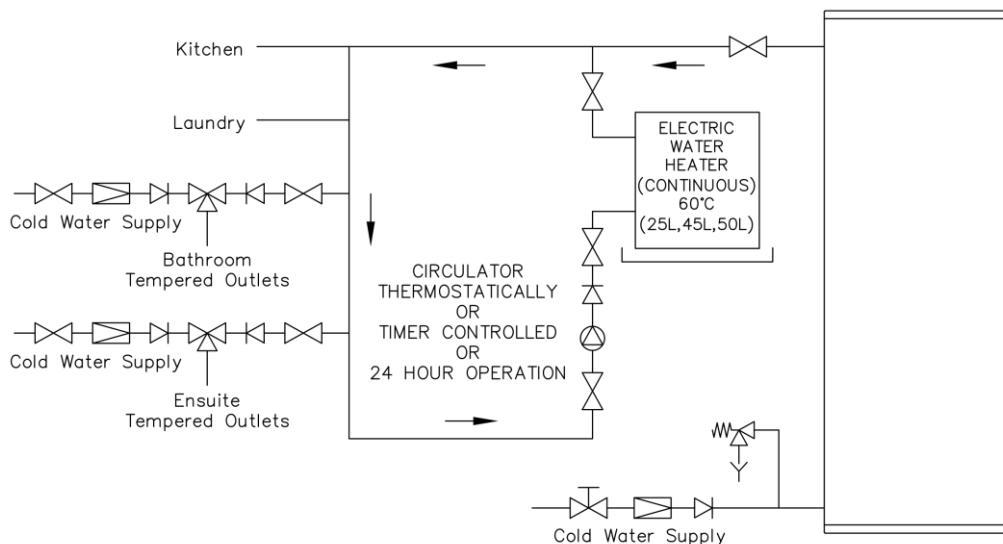

**NOTE:** A PLV IS REQUIRED TO BE INSTALLED ON THE COLD SUPPLY LINE TO THE TEMPERING VALVE IF A PLV IS INSTALLED ON THE COLD SUPPLY LINE TO THE WATER HEATER.

**Circulated Hot Water Flow and Return System - Heat Pump Water Heater**

**REDUCING HEAT LOSSES**

The cold water line to and the hot water line from the water heater must be insulated in accordance with the requirements of AS/NZS 3500.4. The insulation must be weatherproof and UV resistant if exposed.

**ANODE TYPES**

The vitreous enamel lined cylinder of the water heater is only covered by the Solahart warranty when the total dissolved solids (TDS) content in the water is less than 2500 mg/L and when the correct colour coded anode is used. If an incorrect colour coded anode is used in the water heater, any resultant faults will not be covered by the Solahart warranty. In addition, the use of an incorrect colour coded anode may shorten the life of the water heater cylinder.

The correct colour coded anode for the water supply being used must be selected and fitted to the water heater for the Solahart warranty to apply to the water heater cylinder (refer to **“Water Supplies”** on page 16 and the **Anode Selection table** on page 16). The black anode is typically fitted as standard.

If an incorrect anode is used, there is also the possibility the anode may become overactive and hydrogen gas could accumulate in the top of the water heater during long periods of no use. In areas where this is likely to occur, the installer should instruct the householder on how to dissipate the gas safely (refer to **“Caution”** on page 17).

**SADDLING - PIPE WORK**

To prevent damage to the cylinder when attaching pipe clips or saddles to the water heater jacket, we recommend the use of self-drilling screws with a maximum length of 13 mm. Should pre drilling be required, extreme caution must be observed when penetrating the jacket of the water heater.

**Note: If the cylinder is damaged as a result of attaching pipe clips or saddles to the jacket, any resultant faults will not be covered by the Solahart warranty.**

**TYPICAL INSTALLATION – OUTDOOR LOCATION**

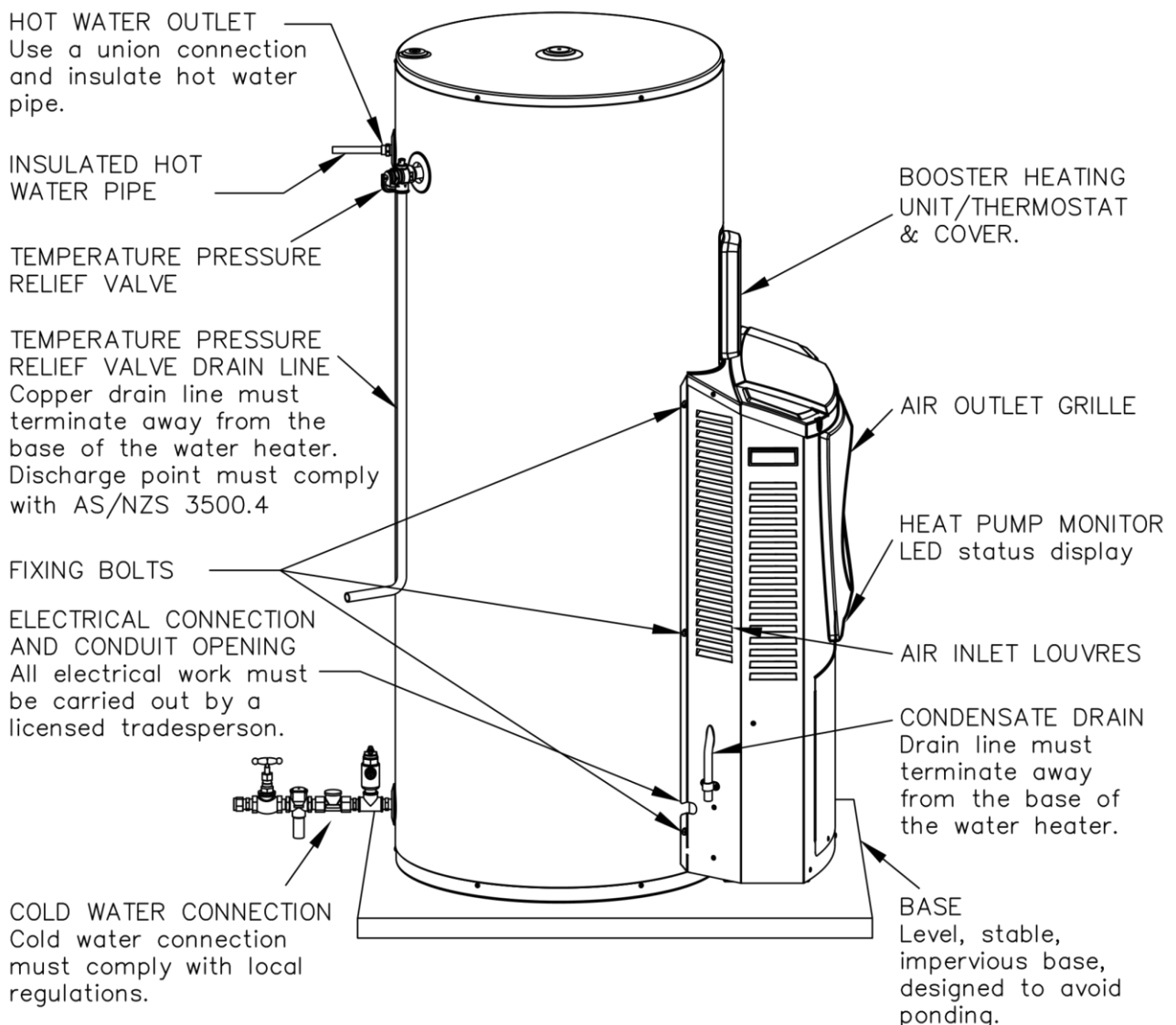

**DIMENSIONS AND TECHNICAL DATA**

**Dimensions**

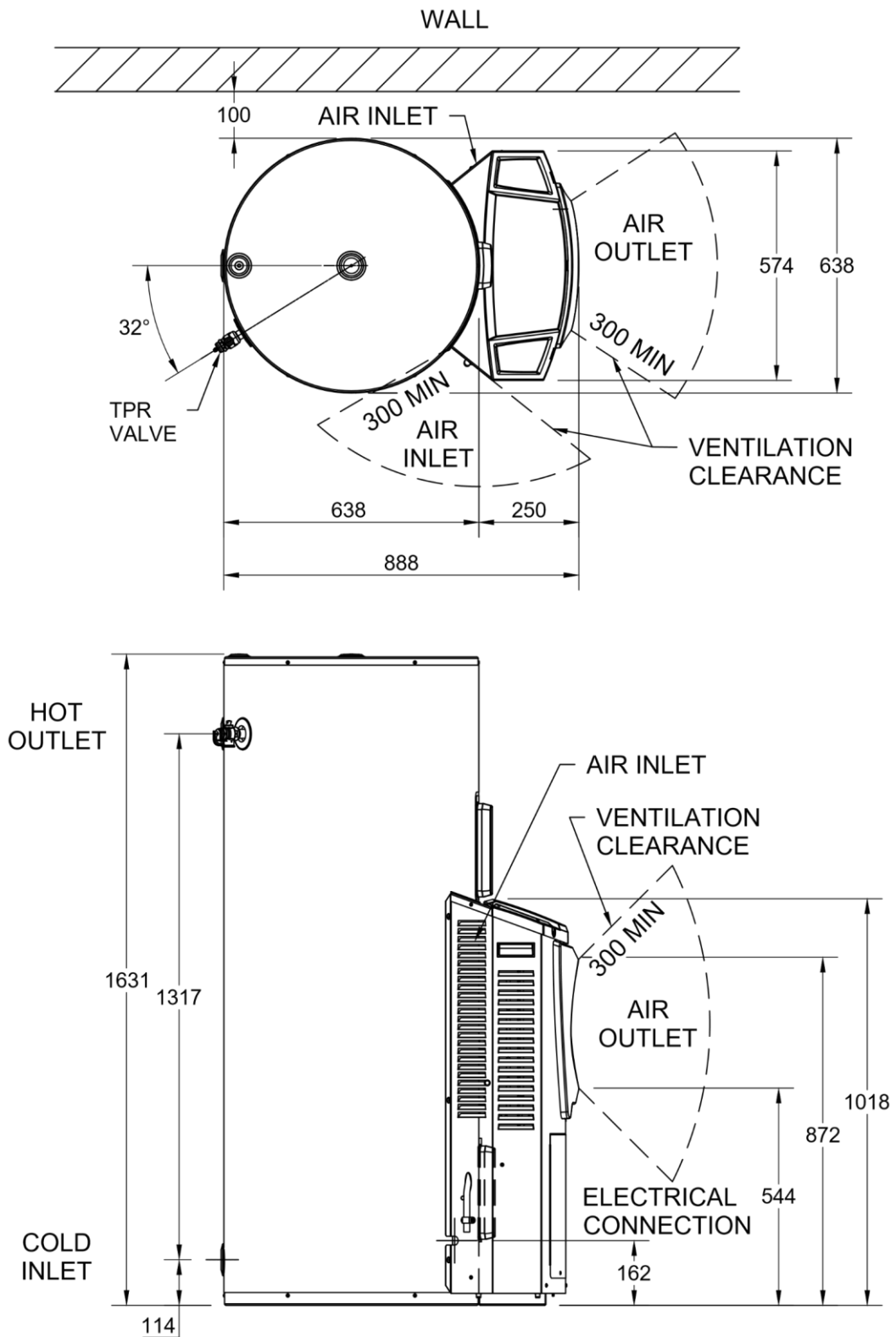

**Model 325HAV**

There is a minimum clearance of 100 mm from a wall behind the water heater

**Technical Data**

<b>Model number</b>		<b>325HAV</b>
Tank product number		R325HAV36
Heat pump module product number		183550
Storage capacity	litres	325
Boost capacity – by electric heating unit	litres	180
Weight tank	cartoned kg	88
Weight heat pump	cartoned kg	42
Weight system	cartoned kg	130
Weight system	full kg	455
Noise level @ 1 metre	dB(A)	52
Rated heat pump power input @ 240 V	watts	800
Electric heating unit rating @ 240 V	watts	3600
Maximum rated power input @ 240 V	watts	3600
Electrical circuit	Amps	20
Refrigerant type		R134a
Refrigerant circuit pressure	kPa	3000

Technical data is subject to change.

IP Rating
IP24

Power Supply
220 V – 240 V
50 Hz

A booster element of a size or type other than the 3.6 kW element supplied may provide a different boost capacity.

**Heat Pump 325HAV Performance Specifications**

Ambient Air Temperature	Relative Humidity	Average Heat Pump Heating Capacity (kW)	Recovery Rate @ 45°C rise (L / hr)	Coefficient of Performance (COP)
9°C	85%	1.5	28	2.8
19°C	67%	2.0	37	3.6
32°C	35%	2.5	48	4.2
33°C	60%	2.6	50	4.5

**Back-Up Heating Unit Recovery Rate @ 240 V**

Heating Unit Rating	Recovery Rate @ 30°C rise (L / hr)	Recovery Rate @ 40°C rise (L / hr)	Recovery Rate @ 50°C rise (L / hr)
3600 watts	103	77	62

**Noise Level** - A noise level of 52 dB(A) was measured at 1 m from the water heater during a Noise Test conducted in an open field. The noise level when installed may be higher due to sound reflections from adjacent walls and structures.

**Ambient Air Temperature & Humidity** – The performance of a Heat Pump changes with ambient air temperature, humidity and incoming water temperature. The warmer the air temperature, the higher the Relative Humidity and the cooler the water temperature, the higher is the heating rate of the heat pump. Performance specifications stated in relation to the heat pump are measured at predefined conditions during its testing.

**Average Heating Capacity kW** – This is how much heating power is put into the water during the heating cycle by the heat pump. It is expressed as an average due to the changes in heating power from the refrigeration cycle as the water is being heated and its temperature increases during the heating cycle.

**Recovery Rate @ 45°C rise L/hr** – Is the number of litres of water that can be heated through a 45°C temperature rise in one hour, e.g., when the air temperature is 19°C, the heat pump can heat 37 litres of water from 15°C to 60°C in one hour.

**COP** – The Coefficient of Performance for a heat pump is the ratio of how much useful heat it produces for water heating to the power input into the water heater. The higher the COP number, the more efficient the heat pump is. A Coefficient of Performance (COP) of 3.6 was measured under test conditions with an ambient air temperature of 19°C/15°C (Dry Bulb/Wet Bulb), heating of the water from 15°C to 60°C during water heater operation and a power supply of 240 V~ 50 Hz. The Heat Pump average heating capacity in Watts (and converted to kilowatts – kW) and its water heating capacity in Litres / hour were calculated from the results of this test.

---

# HEAT PUMP AND TANK ASSEMBLY

---

## STORAGE TANK AND HEAT PUMP MODULE

The heat pump water heater is made of two main components, the storage tank and the heat pump module. For transport and handling (weight) purposes both items are shipped separately and designed to be assembled at the installation site. The water heater must not be operated until both components are assembled.

The water heater is to be installed at ground or floor level and must stand vertically upright on a stable base, such as a level slab or solid base, as acceptable to local authorities, of a minimum 900 mm wide x 650 mm deep. The heat pump module must be fully supported by the stable base.

## HEAT PUMP MODULE

The heat pump module is shipped in a box containing two hand holes to facilitate easy handling and lifting. The heat pump module is to be mounted against the side of the storage tank and must be fully supported by the level slab or solid base.

**CAUTION:** The heat pump module weighs approximately 42 kg when cartoned. Use the hand holes provided in the sides of the packaging. Good lifting practice should be followed.

There are two flexible hoses provided inside the heat pump module. The flexible hoses are to be withdrawn from the module and fixed to the two water fittings on the heat pump storage tank during the assembly procedure.

There are two connection points located on the underside of the control box in the heat pump module to which the power cable and tank sensor cable from the heat pump storage tank are connected during the assembly procedure.

## STORAGE TANK

The storage tank is designed to receive the heat pump module. There are two water fittings located at the side of the storage tank to which flexible hoses from the heat pump module are connected during the assembly procedure.

A power cable is housed behind the lower cover and a tank sensor cable is located adjacent to and above the lower cover of the storage tank. The power cable is to be withdrawn from behind the front cover and the tank sensor cable unfurled and both connected to the control box in the heat pump module during the assembly procedure.

The heat pump module is to be secured to the heat pump tank with three studs and flange nuts, and three fixing bolts.

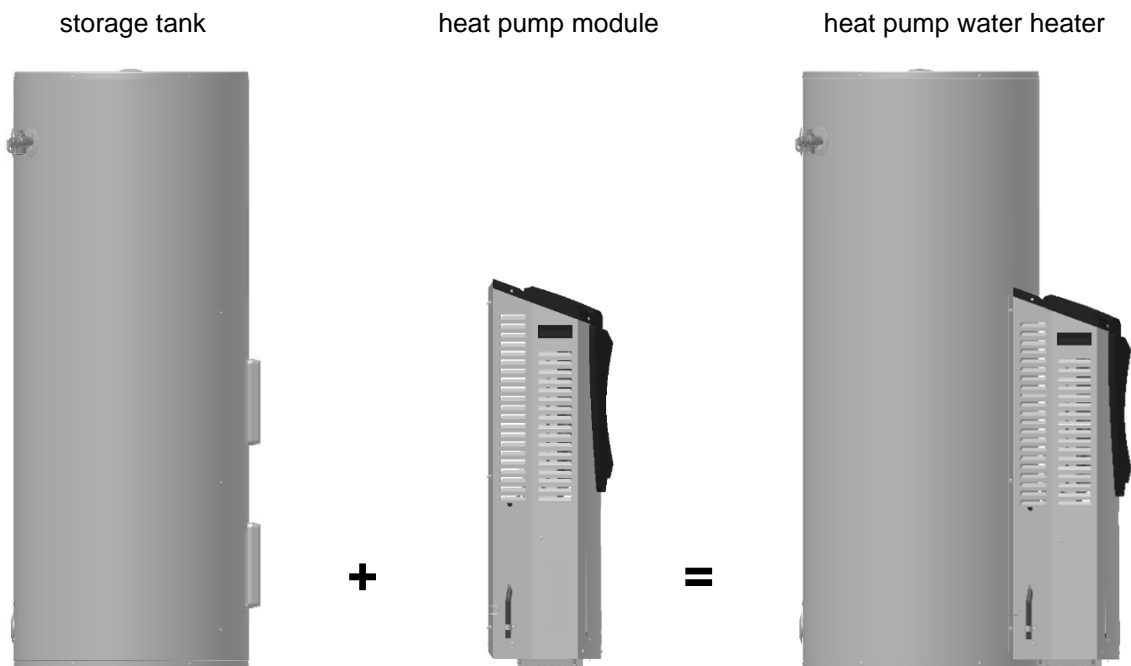

**KIT**

There is a kit (PN 299298) supplied with the heat pump module.

The components supplied in the kit and required for the installation are:

299298	Kit Installation Heat Pump Module Integrated	Quantity
122641	Installation instructions heat pump module S2 integrated	1
052158	Saddle clamp 20 mm Clipsal 261/20	1
080031	Screw phillips pan head No. 8 x 13 zinc plated black	2
080156	Screw pack of 3 M6 x 12 HD bolts	2
080203	Stud M6 x 25 zinc plate	3
080204	Nut hex whizzlock M6	3
104767	Cover fan shroud	1
080191	Screw hilo 13-16 x 20 pan head combination zinc plated	1
104766	Plug plastic 13 mm black	1

**ASSEMBLY PROCEDURE**

**⚠ Warning:** The heat pump must be assembled, plumbed and filled with water prior to power being connected and switched on.

The following procedure should be followed to properly place the heat pump module in position and connect to the storage tank:

1. **Heat Pump Storage Tank:** Remove all packaging including the carton base from the heat pump storage tank and position in its intended location, supported by a stable base.

The water connections may be on either the left or right hand side and should be parallel to the wall.

The storage tank must be positioned at least 100 mm from the wall. If a minimum clearance of 100 mm is not allowed for, the heat pump module will not be able to be completely connected to the storage tank.

The storage tank must also be positioned such that when the heat pump module is in position, there is a clearance of at least 300 mm perpendicular from both the front air inlet louvres and the outlet grille to any wall or obstruction.

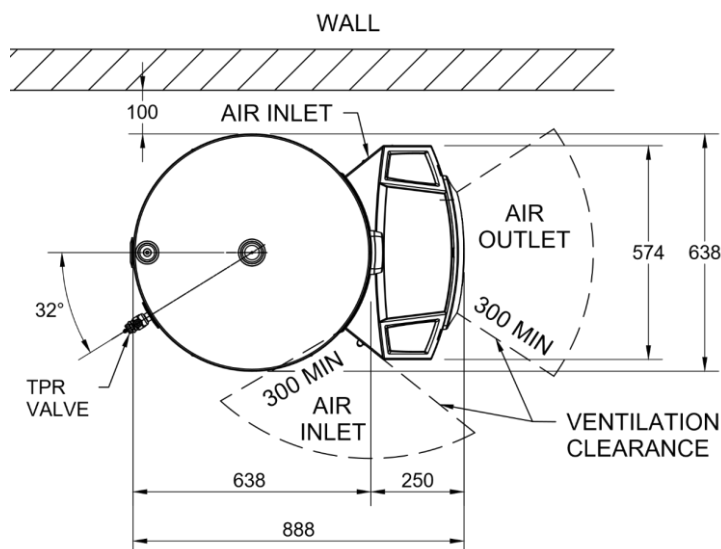

**Step 1 – position storage tank at least 100 mm from the wall and allow for at least 300 mm ventilation clearance**

2. **Lower Front Cover:** Remove the two screws securing the lower front cover to the storage tank.
  - Remove the lower front cover from the storage tank.



**Step 2**  
remove screws  
from lower front cover



**Step 3**  
withdraw the power cable

3. **Power Cable:** Withdraw the power cable, housed behind the lower front cover, from the opening.
4. **Mains Power Connection:** Connect the mains power supply wiring to the terminal block and earth connection inside of the lower front cover.
  - Secure the conduit to the side of the storage tank with the saddle clamp and screws provided.

The saddle clamp must be positioned over the pilot holes provided, otherwise the conduit will interfere with the heat pump module installation.

Refer to **“Connections – Electrical”** on page 43.

**Note:** The power supply to the water heater must not be switched on until the installation is complete, the water heater is filled with water and a satisfactory megger reading is obtained.

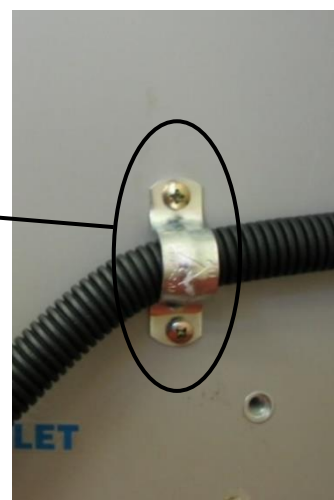
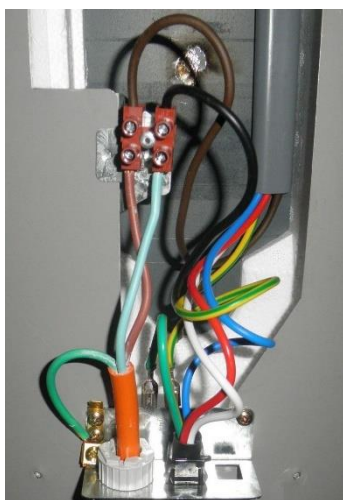

**Step 4**  
connect wiring and secure conduit with saddle clamp



5. **Lower Front Cover:** Refit the lower front cover.



**Step 5**  
refit lower front cover



**Step 6**  
remove tape from tank sensor cable

6. **Tank Sensor Cable:** Remove tape from tank sensor cable and unfurl.
7. **Heat Pump Module:** Remove all packaging including the carton base from the heat pump module and position in its intended location at the storage tank.

**CAUTION:** The heat pump module weighs approximately 42 kg when cartoned. Use the hand holes provided in the sides of the packaging. Good lifting practice should be followed.

8. **Fan Cover Shroud:** Retrieve the fan cover shroud, 20 mm screw and black plastic plug from the kit bag.

- Remove the screw located immediately above the monitor label on the front of the heat pump module and discard.
- Position the fan cover shroud over the fan cowl and slide the recessed edge of the shroud under the lip of the heat pump module top. It will slide under the top without having to remove any screws.
- Align the mounting hole at the bottom of the shroud with the screw hole in the heat pump module located immediately above the monitor label.
- Secure the fan cover shroud to the heat pump module with the 20 mm screw provided.
- Insert the black plug provided into the recess to cover the head of the screw.

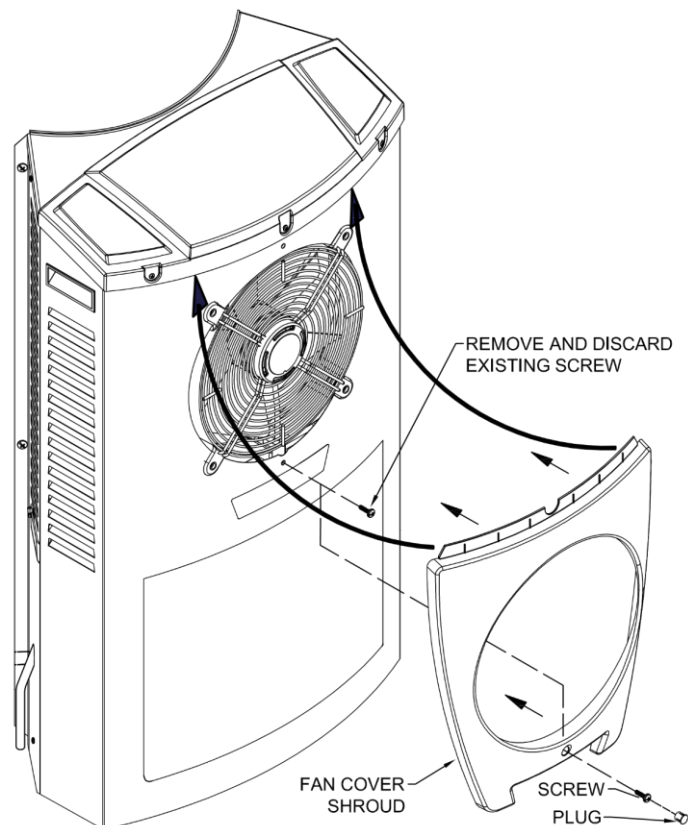

**Step 8**  
fit the fan cover shroud to the heat pump module

9. **Heat Pump Module Cover:** Remove the two screws securing the front cover to the heat pump module.
  - Remove the front cover from the heat pump module.



**Steps 9 and 11**  
**remove front cover from heat pump module and feed through cables**

10. **Position Heat Pump Module:** Position the edge of the heat pump module which is closest to the wall against the storage tank so the screw holes in the module are adjacent to the nutserts in the storage tank.
11. **Power Cable and Tank Sensor Cable:** Feed the power cable from the lower front cover and tank sensor cable through the heat pump module so they protrude out of the front of the module.

12. **Flexible Braided Hoses:** Retrieve the loose ends of the two flexible braided hoses from within the heat pump module, and withdraw through the rear of the heat pump module.
13. **Cold Hose Connection:** Attach the flexible braided hose, marked with a blue stripe through the braid and attached to the bottom of the heat exchanger, to the ball valve fitting in the bottom connection on the storage tank and marked "TO HEAT PUMP".
- Tighten the swivel nut on the hose using a 24 mm spanner.  
Tape or sealant is not required.
  - Position the hose such that when the heat pump module is moved and secured to the tank, it does not kink.
  - **Ball valve:** Ensure the ball valve located in the connection fitting is in the open position. In the open position, the slot is in line with the hose.



**Step 13**  
**attach flexible hose with blue stripe to inlet and ball valve in open position**

14. **Hot Hose Connection:** Attach the flexible braided hose, marked with a red stripe through the braid and attached to the top of the circulator, to the non-return valve fitting in the upper connection marked "OUTLET" in red on the storage tank.
- Tighten the swivel nut on the hose using a 24 mm spanner.  
Tape or sealant is not required.
  - Position the hose such that when the heat pump module is moved and secured to the tank, it does not kink.

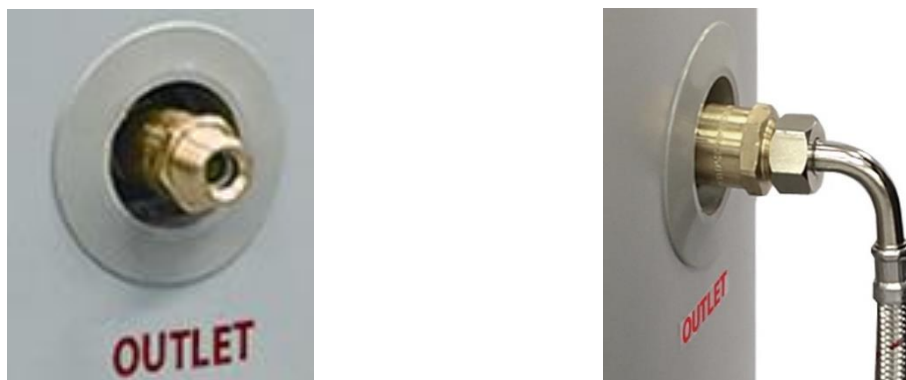

**Step 14**  
**attach flexible hose with red stripe to outlet**

15. **Check Hoses:** Check to ensure the flexible hoses are not kinked.

16. **Cable Tab:** Remove the tab on the side of the electrical entry to the heat pump module to accommodate the electrical conduit.

Pliers or tin snips may be required to remove the tab.

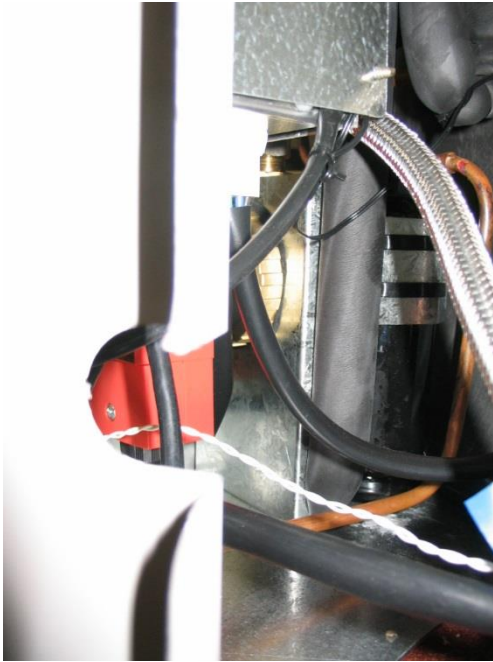

**Step 16**  
remove the tab on the side of the electrical entry to the heat pump module

17. **Studs:** Retrieve the three (3) studs from the kit and screw into the three (3) threaded inserts on the side of the tank closest to the wall.

These studs will assist in aligning the heat pump module for connection to the storage tank.



**Step 17**  
screw in studs into threaded inserts

18. **Position Heat Pump Module:** Position the heat pump module against the tank.
- Engage the tab at the bottom of the heat pump module, on the wall side of the module, into the slot in the tank.
  - Align the holes in the side of the heat pump module over the three studs.
19. **Flange Nuts:** Screw the three flange nuts onto the studs to connect the wall side of the heat pump module to the storage tank.

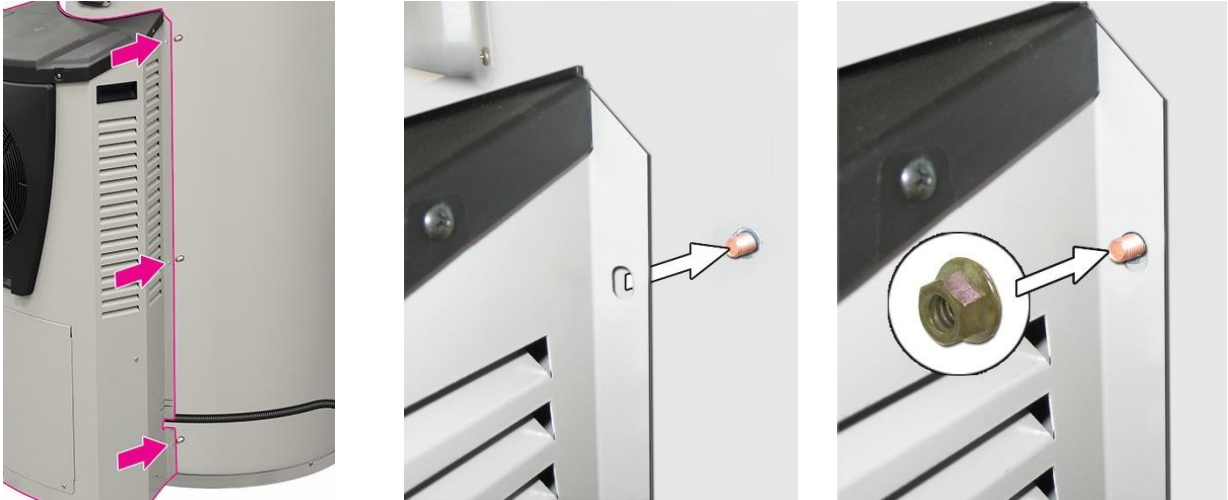

**Steps 18 and 19**  
align heat pump module over studs and screw on flange nuts

20. **Tab:** Engage the tab at the bottom of the heat pump module, on the front side of the module, into the slot in the tank.
21. **Fixing Bolts:** Screw in the three fixing bolts to connect the front side of the heat pump module to the storage tank.

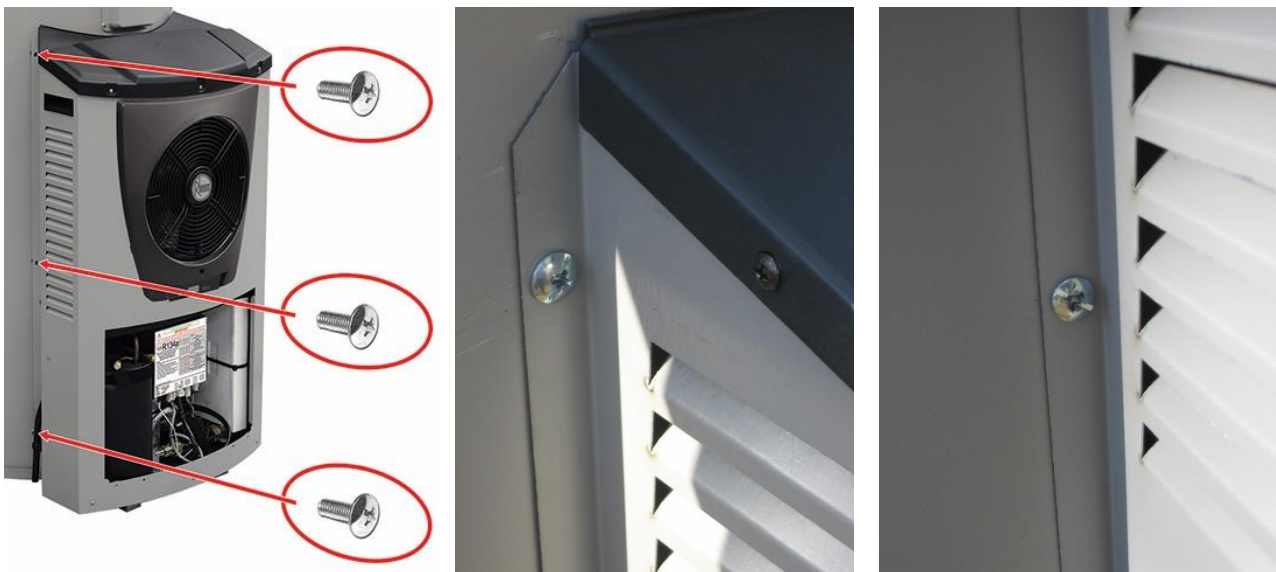

**Step 21**  
screw in fixing bolts to connect heat pump module to storage tank

22. **Tank Sensor Cable Connection:** Insert the tank sensor cable plug to the connector on the underside of the control box.

The plug is polarised and can only be inserted one way.

- Ensure the plug fully engages the locking feature on the connector.

23. **Power Cable Connection:** Insert the four pin power cable plug to the connector on the underside of the control box.

The plug is polarised and can only be inserted one way.

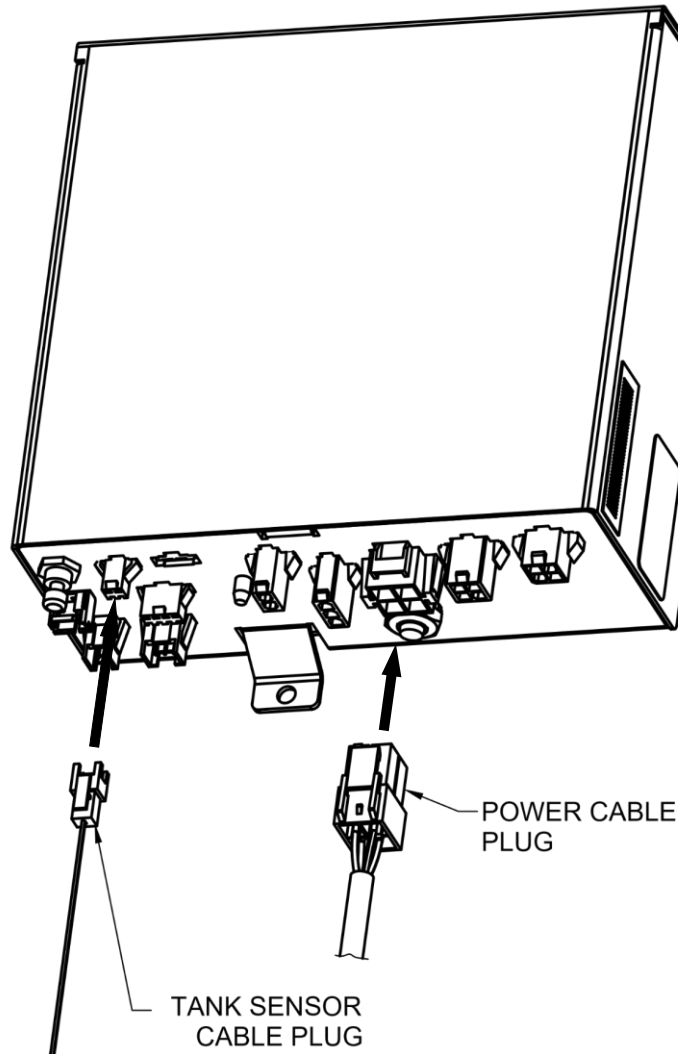

**Steps 22 and 23**  
**connect power cable and tank sensor cable**

24. **Positioning of Water Heater:** Complete final positioning of the water heater.

Ensure the heat pump module is firmly seated on the level slab or solid base.



25. **Water Connections:** Connect the cold water supply and the hot water pipe work to the water heater.
- Connect the temperature pressure relief valve and its drain line.  
Refer to **“Connections – Plumbing”** on page 40.
26. **Water Supply:** Turn on the cold water supply and fill the water heater.
- Check the pipe work and the connection points for the flexible braided hoses for leaks  
Refer to **“To Fill And Turn On The Water Heater”** on page 45, however the electrical supply should not be turned on at this stage.
27. **Heat Pump Module Cover:** Replace the heat pump module cover and re-fit the two screws.



**Step 27**  
**replace heat pump module front cover**

28. **Commissioning:** Refer to **“Commissioning”** on page 45.

---

## CONNECTIONS – PLUMBING

---

All plumbing work must be carried out by a qualified person and in accordance with the requirements of the Standard AS/NZS 3500.4, and all local codes and regulatory authority requirements.

### CONNECTION SIZES

- Hot water connection: Rp 3/4.
- Cold water connection: Rp 3/4.
- Relief valve connection: Rp 1/2.

### WATER INLET AND OUTLET

The pipe work must be cleared of foreign matter before connection and purged before attempting to operate the water heater. All olive compression fittings must use brass or copper olives. Use an approved thread sealant such as Teflon tape on all threaded joints.

An isolation valve and non-return valve must be installed on the cold water line to the water heater. An acceptable arrangement is shown in the diagram. Refer also to “Hot Water Delivery” on page 25 and to “Mains Water Supply” on page 25.

A disconnection union must always be provided at the cold water inlet and hot water outlet on the water heater to allow for disconnection of the water heater.

This water heater has either a plastic dip tube or fitting liner in the inlet and outlet fittings (see diagram). These must be in place for the water heater to function properly. Do not remove or damage them by using heat nearby. They will be pushed into the correct position as the fitting is screwed in.

This water heater is intended to be permanently connected to the water mains and not connected by a hose-set. A braided flexible hose or semi-flexible connector may be used for connection to the water heater, where permitted by AS/NZS 3500.4.

### PIPE SIZES

To achieve true mains pressure operation, the cold water line to the water heater should be the same size or bigger than the hot water line from the water heater.

The pipe sizing for hot water supply systems should be carried out by persons competent to do so, choosing the most suitable pipe size for each individual application. Reference to the technical specifications of the water heater and local regulatory authority requirements must be made.

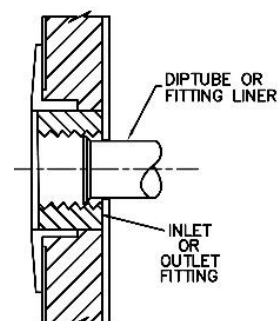
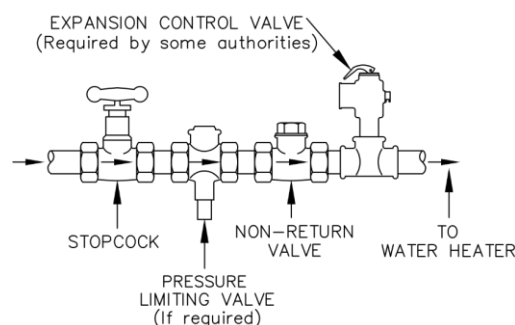



## TEMPERATURE PRESSURE RELIEF VALVE

The temperature pressure relief valve is shipped behind the lower front cover or of the water heater. The temperature pressure relief valve must be fitted before the water heater is operated. Before fitting the relief valve, make sure the probe has not been bent.

To fit the relief valve:

- Seal the thread with an approved thread sealant such as Teflon tape - never hemp. Make sure tape does not hang over the end of the thread.
- Hand tighten the valve into the opening marked "Relief Valve" (refer to the [installation diagram](#) on page 27).
- Using a spanner engaged on the valve's spanner flats and applying medium pressure to tighten, turn the relief valve an additional ½ to 1 ½ turns to secure and make the joint water tight, leaving the valve drain pointing downwards.

**⚠ Warning:** Do not use a pipe wrench or poor fitting tool on the valve body nor over tighten the valve, as this could damage the valve and prevent safe operation.

- Operate the easing lever on the valve to check the smooth operation of the valve plunger. It is very important the lever is raised and lowered gently. The lever should move smoothly and without undue force.
- If the lever cannot be moved or is jerky in its movement, then the valve has been damaged and must be replaced.
- A copper drain line must be fitted to the temperature pressure relief valve (refer to ["Relief Valve Drain"](#) on page 41).
- The valve must be insulated with closed cell polymer insulation or similar (minimum thickness 9 mm) and the insulation installed so as not to impede the operation of the valve.

The insulation must be weatherproof and UV resistant if exposed.

## EXPANSION CONTROL VALVE

Local regulations may make it mandatory to install an expansion control valve (ECV) in the cold water line to the water heater. In other areas, an ECV is required if the saturation index is greater than +0.4 (refer to ["Water Supplies"](#) on page 16).

The expansion control valve must always be installed after the non-return valve and be the last valve installed prior to the water heater ([refer to diagram on page 40](#)). A copper drain line must be fitted to the expansion control valve ([refer to "Relief Valve Drain" on page 41](#)).

The valve, if installed within 500 mm of the water heater, must be insulated with closed cell polymer insulation or similar (minimum thickness 9 mm) and the insulation installed so as not to impede the operation of the valve. The insulation must be weatherproof and UV resistant if exposed.

## RELIEF VALVE DRAIN

DN15 copper drain lines must be fitted to the temperature pressure relief valve and expansion control valve (if one is installed) to carry the discharge clear of the water heater. Connect the drain lines to the valves using disconnection unions. The drain line from the valve to the point of discharge should be as short as possible, have a continuous fall all the way from the water heater to the discharge outlet and have no tap, valves or other restrictions in the pipe work.

A drain line from a relief valve must comply with the requirements of AS/NZS 3500.4.

A drain line must be no longer than 9 metres with no more than three bends greater than 45° before discharging at an outlet or air break. The maximum length of 9 metres for a drain line is reduced by 1 metre for each additional bend required of greater than 45°, up to a maximum of three additional bends. Where the distance to the point of final discharge exceeds this length, the drain line can discharge into a tundish.

Subject to local regulatory authority approval, the drain lines from the temperature pressure relief valve and expansion control valve from an individual water heater may be interconnected.

The outlet of a drain line must be in such a position that flow out of the pipe can be easily seen, but arranged so discharge will not cause injury, damage or nuisance. The termination point of a drain line must comply with the requirements of AS/NZS 3500.4. Drain lines must not discharge into a safe tray.

In locations where water pipes are prone to freezing, drain lines must be insulated, must not exceed 300 mm in length and are to discharge into a tundish through an air gap of between 75 mm and 150 mm.

If a drain line discharges into a tundish, the drain line from the tundish must be not less than DN20. The drain line from a tundish must meet the same requirements as for a drain line from a relief valve.

 **Warning:** As the function of the temperature pressure relief valve on this water heater is to discharge high temperature water under certain conditions, it is strongly recommended the pipe work downstream of the relief valve be capable of carrying water exceeding 93°C. Failure to observe this precaution may result in damage to pipe work and property.

### **CONDENSATE DRAIN**

A drain line should be fitted to the heat pump module's condensate drain to carry the discharge clear of the water heater. The drain line can be extended using 12 mm rigid poly hose or conduit. The pipe work from the condensate drain should be as short as possible and fall all the way from the water heater with no restrictions. It should have no more than three right angle bends in it. The outlet of the drain line must be in such a position that flow out of the pipe can be easily seen - but arranged so water discharge will not cause damage or nuisance.

**The condensate drain line must not be connected to the relief valves drain lines but may discharge at the same point.**

---

## CONNECTIONS – ELECTRICAL

---

**The power supply to the water heater must not be switched on until the water heater is filled with water and a satisfactory megger reading is obtained.**

### MEGGER READING

When a megger test is conducted on this water heater, then the following should be noted.

**⚠ Warning:** This water heater contains electronic equipment and 500 V insulation tests must only be conducted between active and earth and between neutral and earth. An active to neutral test WILL damage the electronics.

**An insulation test result of greater than 1 MΩ for this water heater is normal.**

### ELECTRICAL CONNECTION

All electrical work and permanent wiring must be carried out by a qualified person and in accordance with the edition of the Wiring Rules AS/NZS 3000 in force in the state or territory at the time of installation, and all local codes and regulatory authority requirements.

The water heater must be directly connected to a 220 V - 240 V a.c. 50 Hz mains power supply. The power supply must be able to supply a minimum of 15 Amps.

**Note:** This water heater must not be connected via a power switching device which allows alternative supply of grid power and photovoltaic (PV) power. The switching of the supplies will cause the water heater to enter a forty five (45) minute start delay mode. Repeated switching will reduce the available heating time for the water heater and can result in an insufficient hot water supply.

The water heater must be on its own circuit with an isolating switch installed at the switchboard. The Wiring Rules requires a second and lockable isolating switch be installed adjacent to but not on or attached to the water heater, and a residual current device (RCD) installed in the electrical circuit to the water heater.

The 325HAV model water heater is recommended for connection to either a 24 hour continuous tariff or an extended off-peak (minimum 16 hours per day – replacement model and climate dependant) power supply. If replacing an electric water heater greater than 250 litres, heat pump connection to a 24 hour continuous tariff is recommended.

A flexible 20 mm conduit is required for the electrical cable to the water heater. The conduit is to be connected to the unit with a 20 mm terminator. Connect the power supply wires directly to the terminal block and earth tab connection, ensuring there are no excess wire loops inside the front cover. The temperature rating of the power supply wires insulation must suit this application, or the wiring protected by insulating sleeving with an appropriate temperature rating if it can make contact with the internal storage cylinder. The temperature of the internal storage cylinder can reach 70°C under normal operation.

The electrical connections between the heat pump module and storage tank are made using mating connectors fitted to these components.

The water heater will only operate on a sine wave at 50 Hz. Devices generating a square wave cannot be used to supply power to the water heater.

### BOOSTER HEATING UNIT AND THERMOSTAT SETTING

The water heater has a booster heating unit and thermostat. The booster heating unit will be automatically activated during periods when the ambient air temperature is outside the heat pump's operating temperature range of between a minimum of 3°C to 5°C and maximum of 45°C to 55°C and heating of the water is required. The thermostat is not adjustable.

**TIMER**

A timer can be installed in the electrical circuit to the water heater. The timer must be weatherproof if it is installed outdoors. It may be desirable for the water heater not to operate between certain hours, such as during the peak period when connected to a Time of Use electricity supply due to a more expensive tariff rate applying. A timer will affect the operating times of both the heat pump circuit and the booster heating unit.

**Note:** If there is a risk of freezing conditions, the electrical supply to the water heater should not be switched off, otherwise damage could result (refer to “Freeze Protection” on page 11).

**WIRING DIAGRAM – WITH ROBERTSHAW “ST” THERMOSTAT**

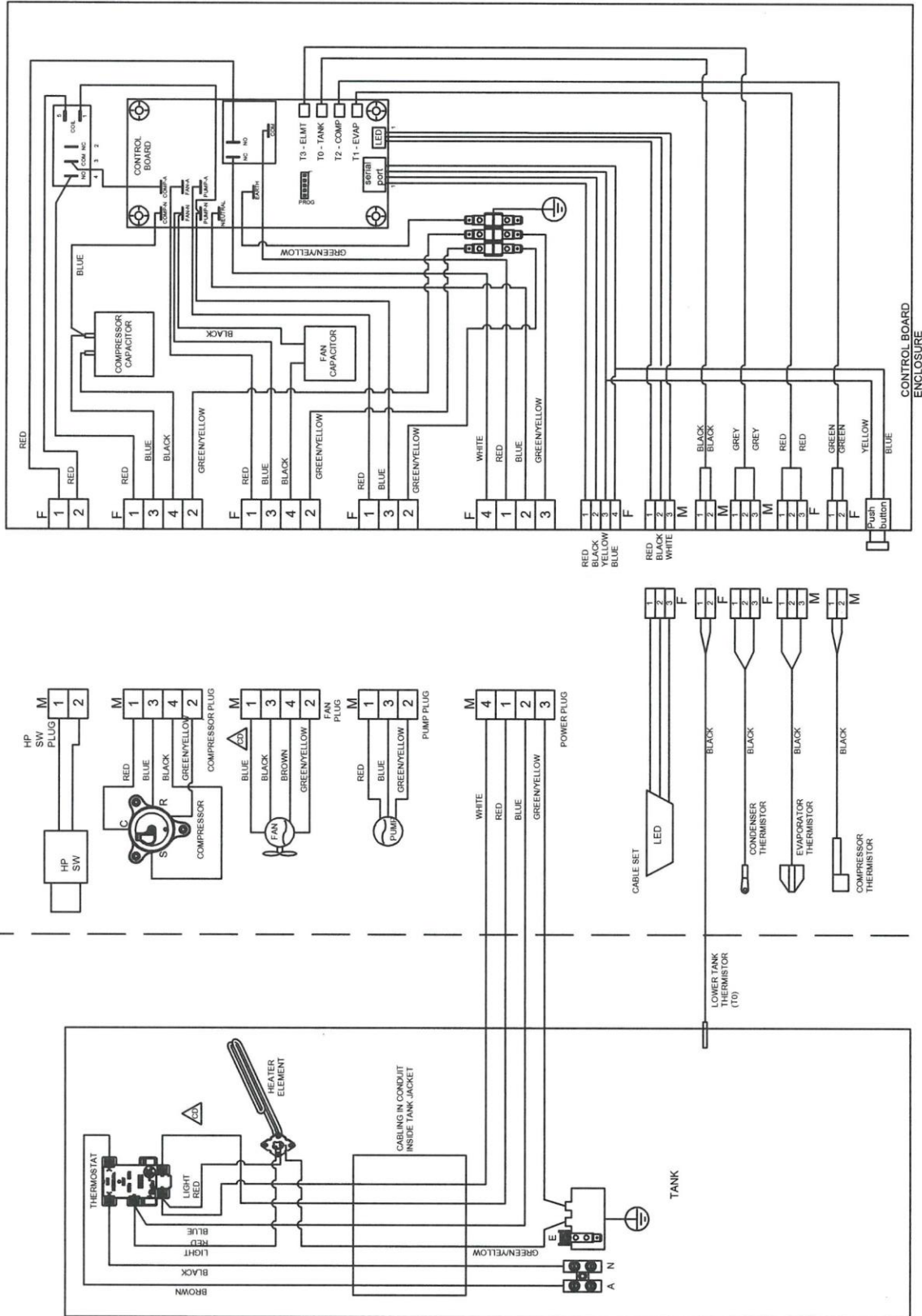

HEATER MODULE ASSEMBLY

TANK ASSEMBLY

---

# COMMISSIONING

---

## TO FILL AND TURN ON THE WATER HEATER

The power supply to the water heater must not be switched on until the water heater is filled with water and a satisfactory megger reading is obtained.

- Open all of the hot water taps in the house (don't forget the shower).
- Open the cold water isolation valve fully to the water heater.

Air will be forced out of the taps.

- Close each tap as water flows freely from it.
- Check the pipe work and the connection points for the flexible braided hoses for leaks.
- Inspect for leaks at the temperature pressure relief valve connection to the water heater.

If a leak is detected, close the cold water isolation valve fully and relieve pressure from the water heater by either operating the easing lever on the temperature pressure relief valve or opening a hot tap. Remove the valve and all of its thread sealant from the threads of the valve. Reapply new thread sealant and refit the valve. Refer to the procedure in "[Temperature Pressure Relief Valve](#)" on page 41.

- Operate the easing lever on the temperature pressure relief valve to check the smooth operation of the valve plunger and that water discharges freely from the drain line. It is very important the lever is raised and lowered gently. The lever should move smoothly and without undue force.

If the lever cannot be moved or is jerky in its movement, then the valve has been damaged and must be replaced.

- Switch on the electrical supply at the water heater isolating switch on the switchboard and at the isolating switch at the water heater.
- Set the timer if one is installed.

**Note:** The water heater is preset in the factory to allow it to commence operating with either the heat pump or booster heating unit immediately power is turned on for the first time. If power is turned on and then off at its installation, the water heater may take up to forty five (45) minutes to commence operating when the power supply is switched on again. This forty five (45) minute period can be overridden during the commissioning procedure if the power was inadvertently turned on and then off again. Refer to "[System Reset](#)" on page 48.

The heat pump will only operate when power is available at the water heater, the water in the storage tank requires heating, the heat pump compressor is cool and the ambient air temperature is within the heat pump's operating temperature range of between a minimum of 3°C to 5°C and a maximum of 45°C to 55°C. If the ambient temperature is outside of this range, the water heater will commence heating with the booster heating unit.

When the heat pump is operating, the system will switch to the booster heating unit if the detected ambient air temperature is outside the operating temperature range of between a minimum of 3°C to 5°C and a maximum of 45°C to 55°C.

The system will not switch back to heat pump operation from the booster heating unit if the detected ambient air temperature has moved back within the heat pump's operating temperature range. The heating cycle will be completed by the booster heating unit.

**Note:** The heat pump may not turn on after either having just completed a heating cycle and more hot water is drawn from the water heater or power is shut down to the compressor, either during or at the end of a heating cycle. The heat pump will wait until the compressor has cooled down and the conditions for start-up are favourable in order to protect the compressor from damage. This will be a minimum of forty five (45) minutes and may take up to ninety (90) minutes from the last heating cycle.

It is important to wait for five (5) minutes after the heat pump has activated to ensure it continues to operate and is functioning correctly.

Explain to the householder or a responsible officer the functions and operation of the heat pump water heater. Upon completion of the installation and commissioning of the water heating system, leave this guide with the householder or a responsible officer.

**TO TURN OFF THE WATER HEATER**

If it is necessary to turn off the water heater on completion of the installation, such as on a building site or where the premises are vacant, then:

- Switch off the electrical supply at the water heater isolating switch on the switchboard and at the isolating switch at the water heater.
- Close the cold water isolation valve at the inlet to the water heater.

**Notes**

- The freeze protection system will be rendered inoperable if electrical power is not available at the water heater.
- Damage caused by freezing due to the unavailability of power at the water heater is not covered by the Solahart warranty (refer to “**Terms of the Solahart warranty**” on page 4).
- If the power has been switched off to the water heater and there is a risk of freezing, then it is necessary to drain the water heater (refer to “**Draining The Water Heater**” on page 48).

**DIAGNOSTIC FEATURES OF THE HEAT PUMP CONTROLLER**

An operating mode monitor is located on the front of the heat pump module and houses a green and a red LED. The green LED, marked “NORMAL”, indicates the current operating mode of the heat pump water heater and the red LED, marked “ATTENTION”, indicates a fault mode.

The green LED will emit either a constant glow or a series of flashes, with a two (2) second interval between each series. A series of long green flashes may also be emitted.

The red LED will emit either a solid glow or a series of flashes, with a two (2) second interval between each series. A series of flashes indicates there may be a particular fault condition with the system.

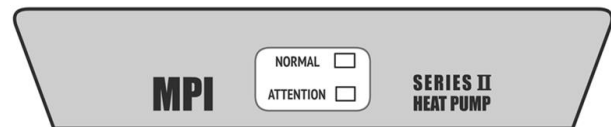

The modes are:

Green LED	Red LED	Operational Modes
solid green (remains on)	off	Standby mode – water is hot
1 x green	off	Call for heating received – system checks performed Note: unit may wait and continue flashing until compressor has cooled from its last operation
2 x green	off	Heat pump preheating
3 x green	off	Heat pump operation – compressor and fan running
4 x green	off	Freeze protection operation – circulator on
long green	off	Heating unit on – ambient air temperature below 3°C to 5°C or above 45°C to 55°C
rapid green	off	System start-up – heating unit on
no green (remains off)	off	No power at the water heater or to the heat pump or a possible fault condition <b>Refer to notes overleaf before calling for service</b>

Green LED	Red LED	Indicator or Fault Modes	
off	1 x red	Compressor over temperature (possible circulator fault)	Heating unit on
off	3 x red	Compressor cooling fault condition	Heating unit on
off	4 x red	Tank thermistor fault condition	Heating unit on
off	5 x red	Evaporator thermistor fault condition	Heating unit on
off	6 x red	Compressor thermistor fault condition	Heating unit on
off	7 x red	Heat exchanger water outlet sensor fault condition	Heating unit on
off	8 x red	Water flow fault	Heating unit on
off	9 x red	Refrigeration system (compressor) fault condition <b>Call for service</b>	Heating unit off
solid green (remains on)	solid red (remains on)	System reset – release button	Heating unit off

## Notes

- **There is no 2 x red flash indicator or fault mode code.**
- **Power must be available at the water heater and to the heat pump for the LEDs to glow or flash.**
- **Time controlled power supply (power must be available at the water heater)**  
If the water heater is connected to a time controlled power supply, then during periods of no power supply at the water heater the LEDs will be off.

This is not a fault condition, but a result of no power being available to energise the LEDs.

The green LED will recommence glowing or flashing when power is available again at the water heater.

- **Heat pump operating range (power must be available to the heat pump)**  
The heat pump's operating range is between an ambient air temperature of a minimum of 3°C to 5°C and a maximum of 45°C to 55°C. The heat pump will not operate when the ambient air temperature is outside the heat pump's operating range.

If heating is required, the water heater will commence heating with the booster heating unit in booster heating mode (long green flash) instead. The water will be heated to 70°C during these periods.

At the completion of this heating cycle by the booster heating unit (long green flash), the thermostat controlling the booster heating unit opens circuit cutting power to the heat pump causing the green LED to go out. This is not a fault condition, but a result of the power being cut to the heat pump by the thermostat.

Refer to "**Heat pump operating range**" on page 19 in the "Save A Service Call" section of this Owner's Guide for further explanation.

- **Possible fault condition**  
If there is power to the water heater and the green LED is off or the red LED is flashing, this indicates there may be a fault condition with the water heater. The red LED may emit up to nine (9) flashes in each series of flashes.

There may be a fault condition with the water heater if either:

- there is power available at the water heater and the green LED is off, and
- the water heater **has not** operated outside of the heat pump's operating range – refer to "**Heat pump operating range**" on page 19.

Before phoning to arrange a service inspection due to the green LED being off, refer to "**Heat Pump Is Not Operating**" on page 19 in the "Save A Service Call" section of this Owner's Guide.

or

- the red LED is flashing – the red LED may emit up to nine flashes in each series of flashes

The fault condition which led to the red LED flashing may be cleared after the backup heating cycle by the booster heating unit has completed. When heating is next required the red LED will recommence to flash the fault code for 27 seconds and then extinguish. If the red LED then recommences to flash or recommences to flash after the heat pump next operates, a service call may be required.

Before phoning to arrange a service inspection due to the red LED flashing, refer to "**Heat Pump Is Not Operating**" on page 19 in the "Save A Service Call" section of this Owner's Guide.



### SYSTEM RESET

To reset the system and override the forty five (45) minute start delay:

1. Press and hold the red controller reset button for two (2) to three (3) seconds until both the green and red LEDs display a solid glow. Release the button.

The reset button is located on the front left corner of the underside of the controller box.

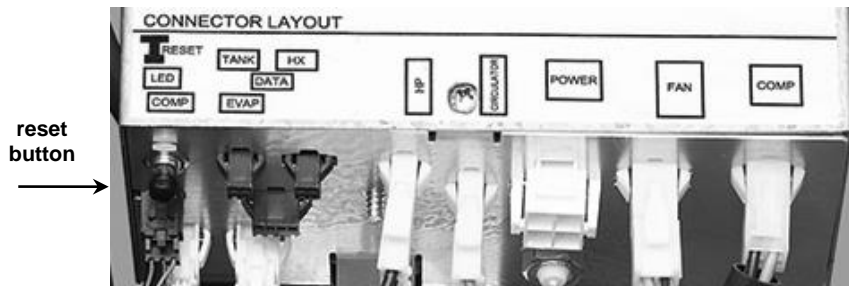

2. The green LED will flash rapidly for three (3) seconds, then the heat pump will commence its heating start-up cycle. A series of 2 or 3 x green flashes will commence.

---

## DRAINING THE WATER HEATER

---

**⚠ Warning:** Exercise care, as water discharged from the water heater may be of a very high temperature.

To drain the water heater:

- Turn off the water heater (refer to **"To Turn Off The Water Heater"** on page 46).
- Close all hot water taps.
- Operate the relief valve lever - do not let the lever snap back or you will damage the valve seat. **It is very important the lever is raised and lowered gently.**

Operating the lever will release the pressure in the water heater.

- Undo the union at the cold water inlet and attach a hose.

Let the other end of the hose go to a drain.

- Open the relief valve by holding the lever in the raised position.

This will let air into the water heater and allow the water to drain through the hose.





# INSTALLATION REPORT

## Dear Customer

A copy of this installation report filled out in full and signed can be attached to an STC Assignment Form (where applicable) as a method to demonstrate proof of installation. It can be copied and kept for your records.

Installer, please complete all details below

<b>Owner's Name</b>							
<b>Installation Address</b>							
<b>Suburb</b>		<b>Telephone Home</b>					
<b>State</b>		<b>Work</b>					
<b>Postcode</b>		<b>Mobile</b>					
<b>Email Address</b>							
<b>Dealership / Agent</b>		<b>No. of Stories of Install</b>		Single	Other		
<b>Installer's Name</b>		<b>Installation Date</b>					
<b>Type of Installation</b> (please circle)	Replace Complete Solar System	Replace Solar Tank	Replace Electric or Gas	Replace Heat Pump	New Building	New Install on Existing Building (not replacing a unit)	Other
<b>System Model No</b>		<b>System Type</b>					
<b>Tank Model No</b>		<b>Tank Serial No</b>					
<b>Electric Booster</b> (please circle)	Electric continuous	Off Peak 1 (night)	Off Peak 2 (night & day)	Solar Preheat only			

If replacing a water heater, please give details

<b>Brand</b>		<b>Model No</b>		Electric	Gas
<b>If a Solahart unit</b>	Tank Serial No		Date of manufacture		
<b>Collector Serial No's</b>	1)	2)	3)	4)	

<b>Comments</b>					
<b>Signature:</b>		Installer:		Customer:	
<b>Date</b>					

---

This page is intentionally blank.

---

This page is intentionally blank.

---

# SOLAHART OFFICES

---

## International Headquarters

**Solahart Industries Pty Ltd**  
(ABN 45 064 945 848)

Registered and Head Office  
1 Alan Street  
Rydalmere, New South Wales, 2116  
Australia

Postal Address:  
PO Box 7508  
Silverwater, New South Wales, 2128  
Australia

Principal Manufacturing Facility  
55 Brodie Street  
Rydalmere, New South Wales, 2116  
Australia

[www.solahart.com.au](http://www.solahart.com.au)

## Australia

For SERVICE Telephone - **1800 638 011**  
or your nearest Solahart Dealer

For Sales Telephone - **1300 769 475**  
or your nearest Solahart Dealer

## International Sales

Telephone International Sales:  
**+ 61 8 9351 4600**

Facsimile International Sales:  
**+ 61 8 9351 4698**

Email:  
**solahart@solahart.com.au**

Web:  
**www.solahart.com**